

ARMY STANDARD DESIGN REQUIREMENTS FOR THE INITIAL ENTRY CHAPEL FACILITY TYPE



JULY 2012

Prepared By:

U.S. Army Corps of Engineers
Omaha District



This page was intentionally left blank for duplex printing.

ARMY CHAPEL FACILITY STANDARD DEFINITIVE DESIGN

<u>1 INTRODUCTION:</u>	<u>3</u>
1.1 DEFINITIVE DESIGN:	3
1.2 SEATING CAPACITY AND SIZES:	3
1.3 ROOM FUNCTIONS AND REQUIREMENTS:	4
1.4 STANDARD DESIGN DRAWINGS AND INFORMATION:	4
1.5 MANDATORY ITEMS:	4
1.5.1 CRITERIA:	4
1.6 OPTIONAL ITEMS:	6
<u>2 SCOPE OF WORK:</u>	<u>8</u>
2.1 IET TYPE (IEC) CHAPEL:	8
<u>3 CHAPELS:</u>	<u>10</u>
3.1 GENERAL REQUIREMENTS:	10
3.1.1 FACILITY DESCRIPTION:	10
3.1.2 FACILITY RELATIONSHIPS:	11
3.1.3 ACCESSIBILITY REQUIREMENTS:	11
3.1.4 BUILDING AREAS:	11
3.1.5 ADAPT BUILD MODEL:	12
3.2 FUNCTIONAL AND OPERATIONAL REQUIREMENTS:	12
3.2.1 FUNCTIONAL SPACES:	12
3.3 SITE FUNCTIONAL REQUIREMENTS:	16
3.4 SITE AND LANDSCAPE REQUIREMENTS:	17
3.5 ARCHITECTURAL REQUIREMENTS:	18
3.5.1 FINISHES AND INTERIOR SPECIALTIES:	21
3.6 STRUCTURAL REQUIREMENTS:	27
3.7 SEE PARAGRAPH 6.7 THERMAL PERFORMANCE – NOT USED	28
3.8 PLUMBING REQUIREMENTS:	28
3.9 COMMUNICATIONS AND SECURITY SYSTEMS:	29
3.10 ELECTRICAL REQUIREMENTS:	31
3.11 HEATING VENTILATING AND AIR CONDITIONING (HVAC) REQUIREMENTS:	32
3.12 ENERGY CONSERVATION REQUIREMENTS:	34
3.13 FIRE PROTECTION REQUIREMENTS:	35
3.14 SUSTAINABLE DESIGN:	37
3.15 SEE PARAGRAPH 6.15 ENVIRONMENTAL DESIGN – NOT USED	37
3.16 SEE PARAGRAPH 6.16 PERMITS – NOT USED	37
3.17 SEE PARAGRAPH 6.17 DEMOLITION – NOT USED	37
3.18 SEE PARAGRAPH 6.18 ADDITIONAL FACILITIES – NOT USED	37
3.19 EQUIPMENT AND FURNITURE REQUIREMENTS:	37
3.19.1 FURNISHINGS:	37
3.19.2 EQUIPMENT:	40

APPENDICES

- A AREA COMPUTATIONS
- B SYSTEMS DESCRIPTIONS
- C COST INFORMATION
- D DRAWINGS

ARMY CHAPEL STANDARD DEFINITIVE DESIGN

1 INTRODUCTION:

1.1 DEFINITIVE DESIGN:

This Standard Design package supersedes versions for this facility type previous to October 2014. It has been established after rigorous evaluation of Lessons Learned from the facilities designed and constructed from the 2004 Army Standard Design, from input by the members of the Army Facilities Standardization Committee (AFSC) and from Office of the Chief of Chaplains (OCCH) research of private sector churches begun in 2008 and extending over a period of several years. This Army Chapel Standard Definitive Design has as its primary goal, the optimum support of military congregations of every sort. It can be used for congregations made up entirely (only) of Initial Entry Trainees (IET), particularly in the intense training setting for high volumes of such trainees. The facility will serve all faiths and the military community without favoring any one distinctive group in orientation or design. The facility is intended for use anywhere in the continental United States or overseas locations. Many features have been incorporated into the design of this facility to give it the maximum ability to adapt to the different needs of all distinctive faith groups and the general military community. This definitive Army Standard Design has been prepared to meet criteria established by the OCCH, and the corresponding Architectural and Engineering design criteria established by the Headquarters U. S. Army Corps of Engineers (HQUSACE) for each project. Within this document, the terms designer, offerer, and contractor are to be considered as synonyms. This better allows this narrative to apply to all of the different acquisition tools used to acquire specific projects. The size and arrangement of spaces, their relationship to one another, and the form of the building are to remain constant during further development of this Army Standard Design into specific projects. **Design goals for construction type, code compliance, sustainability (LEED, energy reduction and efficiency goals), security (anti-terrorism/force protection (AT/FP) and similar concerns) will need to be applied to specific projects as they are applicable.** These supplemental criteria will be identified for each specific project developed from this standard at the time project design work is authorized. The core functional criteria used in the development of this facility type are as follows:

- A. Support the worship services of all distinctive faith groups including the accommodation of various sub-types of services, to include sacramental, dedication, marriage, memorial and funeral ceremonies. Support Soldier ministry programs and religious pastoral care of many kinds.
- B. Support administrative activities necessary to operate and maintain the chapel in a manner that ensures maximum support for the military community and the Garrison.
- C. To do so in a facility that provides the highest levels of personal safety, resource integrity and construction technology while also inspiring and encouraging the Army community and the individual user.

1.2 SEATING CAPACITY AND SIZES:

- A. This Army Standard Design (trainee congregations only) IET Type (IEC) Chapel facility type has fixed seating for the intended needs of the “regular” weekly congregation gatherings. As the primary large group gathering space, the Worship Center has been designed to accommodate the greater seating and fast-turnover needs of the typical IET set of multiple congregations. In addition, broadcasting technology, can allow other smaller spaces within the facility to support remote viewing for attendance demands even greater than has been provided for in the Worship Center.
- B. This size of the facility type is identified as IET Type (IEC) Chapel. It is 37,000 square feet in area with a “regular” weekly congregation target of 1400 persons in the Worship Center.

1.3 ROOM FUNCTIONS AND REQUIREMENTS:

A. Most space types are shared by all sizes/types of chapel facility with proportional differences in quantity or area as appropriate.

B. Each variation in size of chapel facility includes some individual offices for chaplains, group offices (Assistant’s Area) and other administrative spaces required for the Unit Ministry Teams. The major space of these chapel facilities is a primary Worship Center or auditorium type space with a podium type raised platform in addition to the seating area and baptistery suite. Other spaces include kitchen/pantry/recycling-center suite, primary entry lobby (reception) area, sacristy/robing suite, an exterior covered area at the primary entry, general use multi-purpose rooms in multiple sizes and some special use suites. These specialized suites accommodate a number of special activities as well as being available for special worship use. Special activities might include blessed sacrament/reconciliation functions, choir rehearsal functions, and nursery functions. The suite concept allows some functions to expand into adjacent space when necessary. The goal is to allow each congregation or community group the optimum usable features for their activities in an environment where all share the benefits of a relatively flexible and extremely functional facility.

C. In addition to these specific spaces each chapel will include appropriate circulation spaces, toilet facilities, storage spaces and equipment spaces for mechanical, electrical, communication and electronic equipment to support the total building and all of its functions. Carefully compare all of the criteria sections (such as Architectural, Interiors, and Electrical) when planning a specific design project.

1.4 STANDARD DESIGN DRAWINGS AND INFORMATION:

Copies of the drawing and text information that constitutes a Standard Design are available from the supporting Center of Standardization (Omaha) U. S. Army Corps of Engineers Omaha District, and numerous military web sites. The primary web site (the address potentially subject to change) to consult is:

"<http://mrsi.usace.army.mil/sites/cos/SitePages/Home.aspx>".

1.5 MANDATORY ITEMS:

The **Army Standard** for Chapel design and construction defines the mandatory Items that must be included in each Chapel facility. This Army Standard refers to all three sizes of Chapel facility so some statements do not apply directly to the Large Chapel. The Army Standard also includes minimum criteria for some things that the Army Standard Design includes more complete and sometimes more stringent criteria. These more stringent criteria are a requirement for any project design developed from this Army Standard Design. The Army Standard is reproduced as follows:

Item	1.5.1 Criteria:
Site Selection and Planning	Locate the IET Chapel within the Basic Training complex area of the installation master plan.
Primary Facility Scope and Capacity - "Worship Support Component"	Provide an IET Chapel with a primary worship space for not more than 1400 occupants. Provide a building scope of not less than 35,000 gross square feet. The Basis of Authorization. <ul style="list-style-type: none"> • The IET Chapel will be authorized when the TRADOC training mission exceeds 10,000 students

	<ul style="list-style-type: none"> The chapel requirement shall be one IET Chapel per 10,000 student population.
Worship Center	Provide a Worship Center with fixed pews (water, soil & wear resistant finish) with padded (water, soil & wear resistant finish) kneelers. Provide pew sections as an arc arrangement focused on the center of the raised presenter's platform. Provide pew capacity for not less than 1400 persons. Provide a column free space with a ceiling height not lower than 20-feet above the floor. .
Immersion Baptistery	Provide an Immersion Baptistery with four separate male and female changing areas, (two male and two female) located adjacent and connected with the Worship Center.
Administrative Offices	Provide not less than two individual chaplain offices and one group chaplain assistance work area.
Multipurpose Rooms	Provide not less than two secondary meeting rooms (Multipurpose Rooms) capable of seating groups of not less than 80 persons.
Sacristy Suite	Provide not less than one Sacristy storage and robing area with all normal features for such spaces. Provide an area of not less than 250 SF.
Kitchen Suite	Provide not less than one kitchen with pantry for the storing and serving of pre-prepared brought-in foods. Provide residential appliances. Provide an area of not less than 200 square feet.
Resource Center	Provide not less than one Resource Center with an area of not less than 150 square feet.
Entrance Areas	Provide twin primary entry/exit areas, each with canopy and integrated access for persons with disabilities.
Toilet Facilities	Provide three separate toilet spaces at each group toilet location. Provide toilet fixtures at a quantity not less than 3 times the normal code requirements for the building population. Provide two separate wash rooms (one male, one female) within the toilet rooms that accommodate Islamic worship requirements.
Storage Rooms	Provide storage rooms to store tables and chairs from the multipurpose rooms. Provide a combined area of not less than 1,200 square feet.
Exterior Appearance	Provide the building with a roof mounted steeple to identify it as religious facility.
Media System	Provide a full-featured audio/visual system with the capability to support separate or identical activities in the Worship Center and each Multipurpose room. The sound and visual aspects of the system and the spaces shall be coordinated for optimum line of sight and sound clarity (i.e. see, hear and understand) by a certified audio/visual technician. The media system must be supported by a raised control space open to the Worship Center.
Energy	Facilities shall be designed in compliance with all statutes and policies regarding energy conservation.

Sustainable Design Development	Facility shall be designed to meet current sustainable design and development policy requirements as established by the Department of the Army.
Accessibility	The Americans with Disabilities Act Accessibility Guidelines (ADAAG) will be met.

A. Additional aspects of the facilities that are mandatory for each Chapel facility are as follows:

- 1) The basic spaces and their arrangement as shown on the plan portion of this Army Standard Design package.
- 2) Appropriate vehicle and pedestrian elements including bicycle parking, sustainability features and landscaping features. The nature of the site and the needs of the specific users must be accommodated.
- 3) The separate storage building must exhibit the same materials and substantial looking construction as the chapel facility. While intended to store yard and sidewalk maintenance items not suitable for storage in the main building (due to small amounts of fuel, etc.) this building should not be treated as an unrelated construction of just any sort of material and appearance.
- 4) **Using the most up-to-date code and government criteria and general industry criteria in effect at the time of the design process.** In addition, the Center of Standardization maintains a specifically assigned Project Coordinator and a Technical Representative available to assist in the application of this Army Standard Design. The Technical Representative is particularly available to help with the host of historical and functional issues that led to its current form and should also be aware of the latest lessons learned and new developments not yet incorporated in the design, programming information and cost information. The Office of the Chief of Chaplains should also be contacted whenever a specific project is being proposed to get their assistance in developing programming data and current priorities.

1.6 OPTIONAL ITEMS:

A. Optional Items that may be included in this facility are as follows:

- 1) The provision of additional parking or access to existing adjacent parking to meet specific needs of the user or Garrison.
- 2) The provision of additional equipment spaces or yards (program scope) to accommodate unusual specific climates.

THIS HEADING AND PAGE TO SUPPORT CONFLICTING FORMATTING NEEDS ONLY

2 SCOPE OF WORK:

2.1 IET Type (IEC) Chapel:

A. Provide an Army Standard Design IET Type (IEC) Chapel as defined herein with appropriate visual and structural adaptation to the assigned site. The Army Standard Design IET Type Chapel is designed to support a “regular” weekly congregation of 1,400 persons or less in the Worship Center. Include all appropriate coordination with the site. Staff capacity will generally be 6 persons. Variations and visitors to the administrative staff might range from 3 to 12 total persons, combined. Provide an enclosure for a “dumpster” container and a small 150 SF exterior storage building for equipment needed to maintain the exterior property. The basic plan is relatively fixed. The general concept behind the plan is to allow for the support of multiple faith groups with a minimum of spaces devoted to any particular faith group, and to provide for a great deal of flexibility in how each individual space might be used. Consequently, visual adaptations that focus on a particular faith group are not acceptable.

B. The basic floor plan as presented here has been developed to meet building functional, sustainable and programmatic requirements. Slight revisions to the floor plan to accommodate variations in structural members or to optimize sustainability and facilitate functionality are acceptable. Examples include, but are not limited to the following: the sizing and location of fenestration, interior door locations and minor wall placement changes.

C. Significant revisions to the floor plan that increase sustainability while preserving programmatic and functional requirements as outlined in the Army Standard may be considered. Recommended changes to the floor plan will only be approved after going through a waiver submission process as outlined by the Office of the Assistant Chief of Staff for Installation Management (OACSIM).

D. Due to the potential length of the review and approval process, the waiver process might not be feasible for a specific project.

THIS HEADING AND PAGE TO SUPPORT CONFLICTING FORMATTING NEEDS ONLY

3 CHAPELS:

3.1 GENERAL REQUIREMENTS:

A. Provide an Army Standard Design Chapel (facility type) as defined herein.

B. Special Coordination Submittals:

Provide the facility with a special list as a design submittal and again as an early construction submittal. This list will itemize the building features that are to be procured by the government to “fit” into the building fabric supplied by the constructor of the building. For example, a kitchen appliance that is not in the contract but is supported by casework, utilities, and similar features that are a part of the contract supplied “building fabric”. The list shall briefly describe the item and the depth/width/height being provided, the coordinating finishes/colors being provided, the utilities/capacities being provided and any other important note necessary for the government to properly select and purchase the item.

3.1.1 Facility Description:

Chapel requirements are for a facility intended to support the worship, fellowship, and varied gathering needs of general military congregations and some specialized congregations. The associated floor plan (provided) has been specifically developed to provide certain required functional capacities and benefits to the Army for this type of religious facility (especially with regard to supporting a wide range of relatively different faith groups) and is mandatory. It includes multiple sizes and types of spaces to allow the facility to better support a diverse religious and general military community. The circulation system and lobbies allow for a smoother flow of incoming and outgoing users as well as multiple groups of users at the same time or one group entering as a second is arriving. This feature also creates some basic acoustic separation between different space types.

A. Facility Goals for the Soldier Community:

- 1) The facility is intended to support the worship services of all distinctive faith groups including the accommodation of various sub-types of services, to include sacramental, dedications, marriages, and memorial ceremonies. This includes supporting, chapel outreach programs, Soldier ministry programs, and religious pastoral care of many kinds. These goals will impact the layouts and designs of casework, hardware, decorating features, etc.
- 2) The facility is intended to support administrative activities necessary to operate and maintain the chapel in a manner that ensures maximum support for the military community and the Garrison. These goals will impact finish choices, fitting quality and selection of features.
- 3) The facility is intended to provide the highest levels of personal safety, resource integrity and construction technology while also inspiring and encouraging the Army community and the individual user. These goals will also impact the layouts and designs of casework, hardware, decorating features, finish choices, fitting quality and selection of features.

B. Facility Goals for Operating Staff:

- 1) All of the individual and group activities require support from the Unit Ministry Teams (the assigned group of Chaplain Staff defined for each Garrison). In turn, these teams require support in the form of professional administrative, activity and personal counseling spaces. Team members will be seeking to support the military community members and their Garrison in three basic ways.
- 2) The Unit Ministry Team is responsible for coordinating the use of all the different spaces by all the different users, many of which will be from the general Garrison military community.

Good coordination will ensure the most efficient and effective use of the facility and the greatest number of satisfied users.

3) The Unit Ministry Team is responsible for planning and producing a number of individual and group functions. These could range from counseling or instructing an individual to leading a large group religious activity.

4) The Unit Ministry Team is responsible for managing the maintenance and operation of the facility and its supporting equipment systems in a way that provides a safe, economical and nurturing environment within the facility and extends the life of the facility to the greatest extent practicable. This will allow the facility to fulfill its mission for many years to come in a very cost effective manner.

3.1.2 Facility Relationships:

A. This facility should be located within the Basic Training complex area of the installation master plan.

3.1.3 Accessibility Requirements:

Provide the physically handicapped complete access to all appropriate spaces (equipment rooms and closets are examples of exceptions). There are spaces for which handicapped access needs to be limited in specific ways.

A. Counters:

Setting all counter heights in a space or a facility to meet accessibility criteria as if they were the only users of the facility is very inappropriate. Kitchen activities, in particular, are inherently group activities where people continually assist one another. Counter heights for base cabinets and apron rails in all spaces may include appropriate portions for the independent use of the handicapped, but the rest (majority) of such features must be designed to accommodate typical adults without special needs.

3.1.4 Building Areas:

A. General:

While this document includes considerable guidance regarding building area, the depth and scope of other competing criteria can lead to points of uncertainty. Contact the Center of Standardization for help clarifying any such questions that will assist in completing a specific design.

B. Gross Area:

Provide gross building area as directed. For some solicitations an "Appendix Q - AREA COMPUTATIONS" will be provided and shall be used for this. Provide the gross building area as shown on the provided drawing. Note also that every building code, life safety code or similar document will want the gross and net areas of the building calculated a different way because they have to focus on specific issues. These other area computations are fine to include on design documents, per se, but must be included in the drawings and specifications with an appropriate label such as "Special Area for Exiting Calculations/Purposes Only:" The phrases "Gross Square Feet" or "Gross Square Footage" must be reserved for the definition herein if it is used on design or contract documents.

C. Half Space:

A comprehensive review of the drawings and associated calculations will reveal that there are features (canopies, for example) whose area is counted as one-half of actual in gross-area calculations and some

features (inaccessible shafts and the thicknesses of partitions, for example) whose area is not specifically counted in net-area calculations.

D. Net Area:

Net space area is defined as the area measured to the inside face of the surrounding partitions or walls. Additional defining information will sometimes be included in an “Appendix Q - AREA COMPUTATIONS” section. Provide net area requirements for functional spaces as defined in the Appendix A - AREA COMPUTATIONS, a part of this document. If net area requirements are not specified in the Statement of Work or Appendix A - AREA COMPUTATIONS, the space shall be sized to accommodate the required function, comply with code requirements, comply with overall gross area limitations and other recognized design principles.

3.1.5 Adapt Build Model:

When an Adapt-Build Model is available to use as a basis for design and/or construction, it will be posted on the Center of Standardization (CoS) web site, noted in solicitation documentation, or made available upon request as follows:

CoS Web Site address: <http://mrsi.usace.army.mil/cos/SitePages/Home.aspx>

CoS address: U. S. Army Corps of Engineers, Omaha District
CENWO-ED-DG
1616 Capitol Avenue
Omaha, NE 68102-4901

Attn: CoS Technical Representative (Askelon M. Parker)

3.2 FUNCTIONAL AND OPERATIONAL REQUIREMENTS:

3.2.1 Functional Spaces:

A. General:

This facility includes individual offices for chaplains, group offices (Assistant’s Area) and other administrative spaces required for the Unit Ministry Teams. The major space of these chapel facilities is a primary “Worship Center” or auditorium type space with a podium type raised platform in addition to the seating area and baptistery suite. Other spaces include a kitchen/pantry room, entry/exit lobbies, reception area, sacristy/robing room, an exterior covered area at the entry/exits, multi-purpose rooms in multiple sizes and some special use suites or spaces. These specialized suites or spaces accommodate a number of special activities for all congregations or particular groups of faiths. The suite concept allows some functions to expand into adjacent space when necessary. The goal is to allow each congregation or community group the optimum usable features for their activities in an environment where all share the benefits of a relatively flexible and extremely functional facility. In addition to these specific spaces each chapel will include appropriate circulation spaces, toilet facilities, storage spaces and equipment spaces for mechanical, electrical, communication and electronic equipment to support the total building and all of its functions. Carefully compare all of the criteria sections (such as Architectural, Interiors, and Electrical) when planning a specific design project. This facility type is intended to be a key asset for the total Garrison and the military community, not a closed asset only for the private use of the Chaplaincy.

B. Primary Spaces:

1) Administrative Space for the Unit Ministry Team:

Provide group offices and individual office spaces. Chaplain’s offices are often utilized as a

counseling space. It is imperative to provide complete confidentiality (protection against understandable speech leaking into adjacent spaces), privacy of counsel (protection against easy identification of those seeking counsel), and personal security (protection against inappropriate actions or false accusations of inappropriate actions of one person against another) be provided.

2) Worship Center:

Provide a worship center. The expected uses of this space require an ability to darken the room quickly and with certainty. The baptistery shall be closed off by means of an ornamental curtain (dossal) (this choice will require some sort of safety gate/door to protect people from falling into the baptismal pool) or other suitable decorative device. Provide high quality fixed pews with integral kneelers for seating in the Worship Center/auditorium. The issue of dealing with wet and possibly soiled soldier trainees that have marched in during inclement weather requires serious consideration. Pew seats, backs, and kneelers may be padded (which is always best for comfort), but any upholstery selected needs to be waterproof and extremely tear/puncture resistant. All wood pews, wood pews with molded plastic inserts for additional comfort, or some additional option may also be good solutions. Materials used in outdoor seating may have application. Changes in the pew array from that shown in the Army Standard Design drawings to make space for camera points or other features/benefits are acceptable. Pew spacing shall be no less than 3'-4" from seat back to seat back. Code requirements for maximum length, aisle spacing, and etc. shall be incorporated in the layout design. Provide a pair of fixed projection screens (sized for the volume of the space and vision clarity) behind/above the speaking platform and a single smaller screen on the balcony front (so that a speaker or song-leader on the raised platform may be able to see the same things as the congregation). The large screens may be integrated into the wall finishes in such a way as to appear to be part of the partition finishes, if this coordinates well with the interior design. At some Garrisons the local chaplains and other members of the project delivery team working together to define the specific A/V system that they desire to operate may prefer rear projection and the drawings accommodate this feature without requiring it. Forward projection or substituting flat-screen televisions or other appropriate technology components for displaying images are also acceptable. The height of the raised platform in this space shall be approximately 2-feet at the primary plain. Provide a telescoping set of choir chair risers (Contractor Furnished/Contractor Installed (CF/CI)) at the rear of the raised platform and integrate the front face of this riser set with the rest of the finishes of the area. Design this riser set to provide an identical seating pattern as used in the choir rehearsal room. Include integral steps that allow access the riser levels. Provide a lighting and sound control area (appropriate counter space and a visual screening front) at the front of the balcony for the over-all space and another at the raised platform within the ramp assembly. Special decorative features and effects for this space are encouraged. Provide an array of 12 substantial, permanently-mounted decorative hooks suitable for hanging religious banners at suitable places around the perimeter of the Worship Center.

3) Baptistery Suite:

Provide a baptistery suite. Special water control features such as applied and sealed strips, special channeling devices or slightly sloped floor portions shall be considered for keeping standing water from escaping into crevices and spaces where it could cause damage. Outside light-introducing features may be provided, but all such features must also keep from interfering with the viewing of baptisms. Provide an ornamental curtain (dossal) (this choice will also require a gate/door to protect persons from accidentally falling into the baptismal pool) or other suitable decorative device to close the baptistery suite from the Worship Center when not in use. Special decorative features and effects for the portion of this space open to view from the worship center are encouraged, but shall be coordinated with any provided for the worship center. Provide a pre-manufactured baptistery pool and system sized for the space and complete with operating features. Provide operating features that allow simple and direct access for operating staff at both the pool location and the equipment location. Provide a packaged system that is capable of filling (once initiated) the baptismal pool to the optimal level of water, automatically shutting down the filling

operation by use of level sensors, and then heating/maintaining the baptismal pool water temperature (85-105 deg. adjustable). The heater shall be of sufficient capacity to raise the water temperature by 50 degrees F in a 24 hour period. Provide a draining operation that allows for partial draining (to fine-tune the water level for special situations) and full draining once initiated. All piping and accessories for connection to the pool shall be provided in positions that are easily accessed (but not inappropriately exposed) for future maintenance or replacement. Provide an easily accessible (from the pool area or active Baptistery Suite) ON/OFF/START/FILL/ADJUST/DRAIN/ETC. control. Consider providing a means of collecting and reusing (for appropriate outdoor purposes) the water (it is not necessary to treat this used water as sacred) used for baptizing once it is ready for draining. The unit shall include a glazed section facing the seating area, non-slip foot surfaces, integral steps, and a fully coordinated operating system with water heater, safety devices (including protection against overflow of the pool), etc.

4) Kitchen Suite:

Provide a kitchen. Provide base cabinets, counter tops and wall cabinets in the kitchen and each pantry (pantry size may require reductions in base cabinet depth). Provide spacing/accommodation for appliances in kitchen, including the warming drawers. The range with oven, hood above the range, microwave, two refrigerators, two warming drawers, and single dishwasher shall be high grade residential kitchen type appliances. Since residential ice makers are not usually designed for a high enough capacity to be appropriate for this facility, they may be commercial type appliances. Coordinate with the Contracting Officer's representative regarding the need for gas or electric ranges and provide all appropriate utilities to support the appliances. Provide open shelving on pantry walls without casework. Provide appropriate materials and hardware for all casework features. Note that the appliance/casework arrangement shown is not intended to limit the designer. Variations that the designer feels will improve the functionality of the space are acceptable. See paragraph "3.1.3 for "Accessibility Requirements." Provide a pass-through window between the Kitchen and the Activity Center (place both the Kitchen and Activity Center edge at standard counter-top height) to support various serving arrangements that the congregations might choose to use. One of the most attractive ways to handle this is to use regular double doors (full swing hinges) on the Activity Center wall and a finished back-of-base-cabinet treatment below the counter-top.

5) Sacristy/Robing Suite:

Provide the sacristy robing room. The under-counter refrigerator shall be a typical high grade residential/office type appliance. Provide the appropriate electrical utilities to support this appliance. Provide base cabinets, counter tops and wall cabinets in the Sacristy/Robing Room and appropriate storage features for each Storage space. Include a hand washing sink, a special Sacarium sink, space for an under-counter refrigerator and all of the special kinds of drawers, racks, and shelves typically required for the storage of miscellaneous ecclesiastical items used to support several faith groups. Provide appropriate materials and hardware for all casework features. Note that the casework arrangement shown is not intended to limit the designer. Variations that the contractor feels will improve the functionality of the space are acceptable.

6) Multi-purpose Rooms and Classroom:

Provide a multi-purpose room and classrooms. Special decorative features and effects for this space are encouraged. Provide a TV wall mount for a flat screen TV and a wall mount for a Media player. Recommend installing Media wall mount below TV. Provide (except classroom) at least 12 lineal feet of base cabinets, counter tops and wall cabinets. Provide appropriate materials and hardware for all casework features. Note that the fixture/casework arrangement shown is not intended to limit the designer. Variations that the designer feels will improve the functionality of the space are acceptable.

C. Support Spaces:

1) Vestibules:

Provide entry vestibules.

2) Lobbies:

Provide lobbies as required. Due to the nature of lobbies, their specific project characteristics must be coordinated with LEED and Garrison requirements since these requirements change over time. Provide supporting features for two (different viewing locations) flat screen televisions to function as electronic message boards. Provide wall mounting brackets for the televisions. Provide the other lobbies with power and communications support and wall mounting brackets for a flat screen television to function as electronic message boards.

3) Corridors:

Provide corridors as required.

4) Stairways:

Provide stairways as required.

Not Used

5) Storage Rooms:

Provide storage rooms. Provide open storage shelving at one end of the administrative supply closet. Provide shelving and robe or clothes storage features in closets where appropriate.

6) Janitor's Closet:

Provide janitor's closets. Janitor's closet shall include a floor mounted mop sink, shelving for supplies, hanging racks for mops and brooms.

7) Toilet Rooms:

Provide toilet rooms. Consider providing a counter with inset lavatories where individual wall mounted lavatories are shown. Where lavatories are placed on an outside wall, provide a short partition in front of the exterior wall for the fixtures and space for air to flow behind. Place plumbing in the inner partition. Other decorative features, such as porcelain tile wall and floor patterns are also acceptable. There is great diversity of design opinion related to toilet rooms, and particular fixtures and accessories can work best in different arrangements. In consequence, it is acceptable to rearrange these spaces so long as the fixture count stays the same. This means that the floor plan (within this perimeter) may vary from the floor plan shown in the Army Standard Design so long as fixture counts are maintained.

8) Equipment Rooms:

Provide equipment rooms. Integrate a full stair into the lower level equipment room for access to any upper level mezzanine. Coordinate location for the best integration with the equipment.

9) Exterior Canopy Covered Areas:

Provide exterior canopies at each entrance with a weather, insect, bird, and vermin resistant ceiling material. Minimum height of canopy ceiling shall be 9'-0". Provide paved surface below with

decorative accent and slip-resistant finish.

3.3 SITE FUNCTIONAL REQUIREMENTS:

A. General:

The Army Standard Design incorporates typical features for threat protection. The level of threat is to be defined by the Garrison and is included in the project design criteria. These criteria are to be referred to for specific definitions and the security measures required to resist a prescribed threat. If greater levels of threat are indicated than accommodated by the typical features of this document, additional features can be added.

B. Building Orientation:

- 1) The building has been designed so that orientation is not critical. However, when possible, locating the entrance doors away from the prevailing winds will help to save energy during colder months in northern climates. Southern exposures of the main entrances are desirable in certain areas to help remove ice buildup on walks. Windbreaks, trees for shade, and preservation of existing landscaping should be considered when selecting a building site, parking areas and walkways. All driveways and parking areas, including trash dumpsters and their enclosures, have location restrictions for force protection reasons.
- 2) Site specific features may have a significant impact on how the building is oriented and located on the site, how much parking is required, the layout and amount of sidewalks, type and amount of landscaping, fencing, etc. Adjacent parking areas may exist that can be used if conflicts in use can be resolved. Certain existing structures or site features may need to be screened from view. In any case the final layout of the building and site will vary from site to site with the best solution quite possibly being one quite different from the one presented in this document.
- 3) The characteristics of some sites may indicate value in using a mirror-image-along-the-long-axis of the building plan. This is acceptable.

C. Parking:

- 1) The site should allow space for the building, an out-door worship gathering area, a service drive, various walkways and necessary force protection distances from any indicated driveway or parking area. Parking acreage requirements for each facility will depend on the size of the facility, how the facility is used, and the availability of adjacent parking areas that may be used. Parking should be considered for overlapping groups of users who may be in separate areas of the facility.
- 2) The average population of the building assumes one congregation in the building at one time with members from other congregations on site, preparing ahead for their "time slot". In addition there might be one or two small specialty congregations meeting in the multipurpose rooms of the chapel building. In most cases troop congregations will march to the site or be bussed. There will be times when general population events will be held in the building and these will require normal parking accommodations. These assumptions would appear to indicate that the average population of the IET Type (IEC) Chapel building would be approximately 1,800 persons.
- 3) At any facility the number of parking stalls needed depends on how many people drive to the facility. If no traffic analysis were done to indicate otherwise, the number of stalls allocated per chapel would be 30% of the seating capacity of the building. If an analysis is done, the number of parking stalls shall be determined based upon the number of users, the level of ride sharing, available public transport, future growth, average employee absence, and the availability of parking areas adjacent to the facility that may be used during those periods of time when conflicts will not occur. Parking stall widths shall never be less than 9 feet wide. 90 degree parking is the most space efficient parking style and can be used in two directional lanes. Angle parking is

usually only one way and less efficient space wise, but quicker and easier to get in and out of. The parking area shall be based on 350 to 400 square feet per parking stall. This square footage accounts for the parking stall the adjacent drive aisle; adjacent parking islands and drive aisles adjacent to the end of the parking lot. Extended drives for access to parking lots and service drives to maintenance areas and drop offs to the front doors, etc., are pavement areas that need to be calculated on a case by case basis depending upon the topography and location of the facility from existing transportation routes.

4) The IET Type (IEC) Chapel, with an average population of 1,800 persons would have a parking area with drive aisles totaling 540 parking stalls, or 24,000 square yards of paving. Additional paving for extended entrance drives, maintenance areas and drop offs should be added to this. In addition, for functional completeness for the Army congregations being served by this facility type, it should be co-located with an appropriately sized (usually the large size) Religious Education Facility. The acreage area necessary for properly accommodating the IET Type (IEC) Chapel and its accompanying Religious Education Facility is approximately 16.5 acres.

D. Access Drives And Lanes:

1) The site plan indicates a drive approaching the building offset from the main entry. This design prohibits a straight line of access for vehicles to the front of the building for force protection reasons. A drop off drive is shown at the main entrance to the chapel. The specific direction for this feature may vary at each Garrison.

2) A service drive of minimal width may be installed on the side of the building for access to the mechanical room. This drive may also serve as an access drive for fire department vehicles. In any case this drive must have a lockable gate or chain to prevent unauthorized access to that side of the building.

3.4 SITE AND LANDSCAPE REQUIREMENTS:

A. General:

1) Existing environmental cues and sustainability issues will be the primary “drivers” for developing the site for specific projects. Landscaping should be designed to be low maintenance, and compatible with the environment in which the facility is located. Consideration should be given to the offices and other rooms located around the perimeter of the structure when locating plant material. Specific views of the buildings should be appropriately landscaped i.e., to enhance the main entrances to screen mechanical or electrical equipment and large parking areas.

2) Site grading is seldom considered early on in a project. However this is a very important aspect of the project. The site elevation of the building can determine the visual-importance of the building in relation to the adjacent features. The location and elevation of the building will determine the slope and grade of the adjacent walks, roadways, lawns and patios serving the building. The most appropriate grades for walkways to the building are 2%. Provide a smooth access-way (without resorting to ramps) for providing handicapped persons access to the facility.

3) The amount and type of storm drainage will impact the site. Consider early on the type of roof drainage and how it will flow across the site. Avoid having downspouts spill out across walkways and main drives making them hazardous especially during freezing periods. Do not direct storm drainage across major walkways or into inlets near major pathways to or from the parking lot. Major drainage swales should not direct water near the main building. Avoid upward slopes near the main structure to avoid snow accumulation against the building and seepage of water into the structure.

B. Site Structures:

Provide screen walls and other site features as appropriate and where directed in other paragraphs.

C. Site Utilities:

Provide as appropriate. Adequate site lighting for pedestrians and cars should also be included in the design. Additional lighting for the facility to accent certain features of the building, landscaping or views should also be considered.

D. Landscaping\Hardscaping:

- 1) Provide as appropriate. Mounding and landscaping can be used to deflect or reduce noise from certain areas. Plantings should be held away from windows and entrances for security purposes. Thick shrubbery and dense plantings should be avoided.
- 2) Small paved areas are located on the outside off the side entrances and exits for outdoor worship or gatherings of large or small groups when weather permits.
- 3) In addition to the above paved areas, provide outdoor activity spaces where requested for specific projects. These could range from an adjacent patio to expand an indoor activity into the outdoors, all the way to a more developed covered or fully outdoor space. Available resources and local climate may encourage the investigation of such features for a specific project. The optional outside worship area has been demonstrated adjacent to the building but distant from any parking areas to reduce the amount of disturbing outside noise and visual clutter. A bicycle parking area should be located near the front entry to the building.

3.5 ARCHITECTURAL REQUIREMENTS:

A. General:

- 1) Visual appearance and exterior material selections shall coordinate well with the patterns set by the Garrison and its existing adjacent facilities. The impact of climate, security and geography shall also be addressed appropriately. There may be reasons to control exterior noise from entering the facility that would require special treatment or STC ratings on major building components. Provide appropriate and adequate protection from the wind and wind driven precipitation for doors and entries. The development of interior design themes shall relate to the exterior design decisions made and it should receive a thoughtfully coordinated treatment throughout all interior spaces. These interior themes shall also be appropriate to the functions housed. Safety and security for all users will require incorporating features such as thoughtfully placed locking hardware, handrails and non-slip (a generally "smooth matte" finish that shall limit the risks of foot slippage when wet, but not try to eliminate them by presenting a protruding abrasive grit or highly textured surface) floor finishes. Door hardware shall take into consideration the high volume of building users through the week. Interior doors shall be of solid core hardwood but a special STC rated design or the inclusion of complex or actuated sealing devices is not necessary or desired. Provide all appropriate (restroom, normally locked equipment room, normally-locked storage room, and very small closet doors are not appropriate) interior doors with narrow borrow lite windows. Rooms like the kitchen pantries that may occasionally be left unlocked should be included. The doors to the Chaplain's offices should have a narrow borrow lite window except that it should also include a "frosted" film or treatment (certain sheer fabrics may also work well) to obscure detail, but still allow a passing observer to note the general placement of people and objects. The goal is to have no accessible space be or appear to be observation free. This has been demonstrated to deter temptation to inappropriate behavior or the claim of inappropriate behavior.
- 2) Provide an exterior building appearance and massing that coordinates with the plan of the

facility. Provide appropriate windows for all appropriate spaces. Window sizes and placement are to integrate with the exterior design theme. Provide window area of a minimum of 10 percent of the exterior wall area (counting wall area below 10 feet above the finished floor) and provide all windows with appropriate sill materials (more than painted gypsum wallboard). Provide a roof slope of at least 3 in 12 for all areas of roofing and snow guards over entrances or other features requiring protection along eave edges of low-friction roofing such as metal. Where porcelain tile is called for, install with epoxy grout.

B. Walls:

The intent of the Army Standard Design for this facility type is to allow for the fullest possible range of exterior wall choices, particularly so that the facility can coordinate optimally with the Aesthetic themes of the Garrison upon which it is constructed.

C. Roof Systems:

The intent of the Army Standard Design for this facility type is to allow for the fullest possible range of roof choices particularly so that the facility can coordinate optimally with the Aesthetic themes of the Garrison upon which it is constructed. Sloped metal roofing does have many benefits for a facility of this type.

D. Openings:

The intent of the Army Standard Design for this facility type is to allow for the fullest possible range of exterior opening choices particularly so that the facility can coordinate optimally with the Aesthetic themes of the Garrison upon which it is constructed.

1) Administrative Space for the Unit Ministry Team:

Provide the group office and individual office space entry doors with locksets. Provide a glazed borrow lite (approximately 6-feet x 3-feet) between the Lobby and Administrative Group Office. Coordinate with the Contracting Officer's representative on the preferred location and provide one of the exterior entry doors for the building with a mechanical push-button or other special keyless entry device for staff use when the facility is closed for regular business. Provide a glazed borrow lite in the door to the Chaplain's offices are required, but it must include a "frosted" film or treatment to obscure detail, but still allow a passing observer to note the general placement of people and objects. See also paragraph "A. Chapel General in section 3.2.1."

2) Worship Center:

Provide the worship center entry doors with locksets.

Not Used

3) Baptistry Suite:

Provide the baptistry suite entry doors with locksets.

Not Used

4) Kitchen Suite:

Provide room entry doors (pantries also) with locksets.

5) Sacristy/Robing Suite:

Provide the sacristy robing room entry door with a lockset. Provide interior-to-the-suite doors with latch sets.

Not Used

6) Multi-purpose Rooms and Classroom :

Provide the multi-purpose room and classroom entry doors with locksets.

7) Vestibules:

Provide vestibule entry doors (from the exterior) with locksets. Provide interior facing doors with appropriate push-pull devices.

8) Storage Rooms:

Provide room entry doors with locksets.

9) Janitor's Closet:

Provide janitor's closet entry door with a lockset.

10) Toilet Rooms:

Provide toilet room entry doors (and ablution cubicle doors).

11) Equipment Rooms:

Provide equipment room entry doors with locksets (coordinate the keying of these spaces with the Garrison groups responsible for maintenance and operation).

E. Spatial Integration:

A key concept of this Army Standard Design involves a three-pronged integration of elements. First, there is the inherent value of a relatively simple roof form for cost efficiency and a long roof life with few problems. Secondly, there is the relationship between spaces where the function requires greater room height and spaces where the function requires only conventional room height. The optimum arrangement of spaces for this facility in plan requires that the former spaces be placed at the core of the plan and the latter spaces be placed on three sides of the core. Provide a building equipment mezzanine above a portion of the conventional-room-height spaces to augment the main floor space provided and integrate this space with the greater-room-height spaces.

F. Exterior Specialties:

1) Steeple:

Provide the facility with an aluminum steeple. In most cases, fire sprinklering of this steeple is not practical. A reading of the various codes will require a prefabricated aluminum steeple structure since integrating non-combustible components into fiberglass is not really practical. The steeple height (including the steeple base cupola) from the roof crown shall be approximately the same height as the building from the ground to the roof crown (it is understood that air space or other restrictions may limit the height from reaching this proportion at some locations) and the width of the steeple base should coordinate with the width of the building. The inclusion of an operating electronic carillon system is encouraged. If the style of the steeple makes it appropriate, a protected way of access from inside the building into the steeple area is also encouraged.

2) Exterior Signage:

Provide electrical conduits and communication conduits for a lighted and substantial exterior building sign (that will accommodate a future electronic message board) at an appropriate area on the site.

G. Acoustical Requirements:

Acoustics is an important consideration in the design of chapels. The following shall be provided:

1) Administrative Space for the Unit Ministry Team:

Partition construction around each space shall supply an STC rating of 45 or better.

2) Worship Center:

Partition construction shall supply an STC rating of 52 or better.

3) Multi-purpose Rooms and Classroom :

Partition construction shall supply an STC rating of 52 or better.

3.5.1 Finishes And Interior Specialties:

A. General:

1) The facility interior shall be a warm, comfortable, and professional environment through the appropriate use of building materials, furniture, finishes, fabrics, color, texture, and the generous use of wood. Coordinate wood finish, such as stain or paint, on a per project basis. Materials and features shall be of high quality, functional, easily maintained and furnished as described herein. In regions where similar materials such as natural stone tiles or other special flooring tiles are competitive in price and provide the same appearance and performance characteristics, these materials are also generally acceptable wherever porcelain tile is specifically called for herein. Recommend the use of several coordinating carpet patterns within the same color-way within the facility to provide variety and continuity between different functional areas. Recommend using variation of color or floor patterns to visually shorten long corridors and add interest. Provide wall and/or floor tile patterns using several coordinating colors in the toilets as appropriate. Tile patterns shall be appropriate to size and shape of rooms. Building finishes and details and furniture style, finish and fabrics shall be complementary and provide a completely coordinated interior design. The interior building appearance shall coordinate with the exterior building appearance. Consider spaces that open up to one another when selecting furniture and building finish and color selections. The criteria within this document identifies the level of quality and special requirements for finishes and furniture, yet provides flexibility for the designer to make creative and appropriate selections to meet User requirements.

2) Interior and exterior building finishes and colors shall be coordinated with the user and Garrison; refer to Section 01 10 00, paragraph 6 for additional guidance. In addition, the exterior building design shall comply with Garrison exterior building guidance.

3) Unless otherwise noted, items in this section shall be Contractor Furnished/Contractor Installed (CF/CI). Dimensions provided are approximate. When a finish has not been included in this paragraph, finish selection will follow applicable standards and User requirements. Designers are not limited to minimum finishes listed in this section and are encouraged to offer higher quality finishes in addition to materials that aid in meeting LEED requirements.

B. Finishes:

1) Administrative Space for the Unit Ministry Team:

Provide carpet tile for the floor finish, resilient base for the wall/floor trim, and painted wallboard protected with chair rails (from moving furniture or carts) for the wall finish. Vinyl wall covering or other accent wall covering may also be appropriate. Provide suspended acoustic tile with recessed light fixtures in a typical grid pattern type exposed suspension system for the ceilings. The ceiling heights shall be 8'-0" above the finished floor.

2) Worship Center:

Provide carpet tile for the floor finish (for IET Type and some other projects, porcelain tile is also acceptable), wood base for the wall/floor trim, painted wallboard protected with chair rail and accented with some form of high quality above-door-height-trim (such as an exaggerated picture molding, a continuous door head molding, a high-on-the-wall plate-rail type molding or a cornice molding) for the wall finish. Vinyl wall covering or other accent wall covering may also be appropriate. Broadloom carpet is recommended at the raised platform in the worship center. Ceilings and lighting format shall be integrated with the ceiling/roof structure. Where possible, provide wave shaped or similarly canted ribbons or islands of ceiling (placed well below the structural roof deck) with light fixtures up and between them so that the ceiling planes both reflect sound and visually "diminish" the light fixtures from the sight of those in the pews. It might also be feasible to include a catwalk system above the ceiling to access the light fixtures and other ceiling devices. The ceiling heights shall be at least 8-feet above the finished floor at the highest balcony seating level.

3) Baptistry Suite:

Provide porcelain tile for the floor finish, porcelain tile base for the wall/floor trim, and painted wallboard for the wall finish. Special wall finishes for these spaces are also acceptable. Walls adjacent to the baptismal pool shall include a porcelain tile wainscot (as a minimum). Ceilings and lighting format shall be integrated with the ceiling/roof structure. The ceiling heights shall coordinate with openings, but shall be not less than 8'-0" above the finished floor.

4) Kitchen Suite:

Provide porcelain tile for the floor finish, porcelain tile base for the wall/floor trim, and painted wallboard for the wall finish. Provide painted wallboard for the ceiling finish and lighting format. The ceiling heights shall be 8'-0" above the finished floor.

5) Sacristy/Robing Suite:

Provide carpet tile for the floor finish, resilient base for the wall/floor trim, and painted wallboard for the wall finish. Provide suspended acoustic tile with recessed light fixtures in a typical grid pattern type exposed suspension system for the ceiling finish and lighting format. The ceiling heights shall be 8'-0" above the finished floor.

6) Multi-purpose Rooms and Classroom:

Provide carpet tile for the floor finish, wood base for the wall/floor trim, and painted wallboard protected with chair rails and accented with some form of high quality above-door-height-trim (such as an exaggerated picture molding, a continuous door head molding, a high-on-the-wall plate-rail type molding or a cornice molding) for the wall finish. Vinyl wall covering or other accent wall covering may also be appropriate. Provide suspended acoustic tile with recessed light fixtures in a typical grid pattern type exposed suspension system for the ceiling finish and lighting

format. The ceiling heights shall be 9'-0" above the finished floor.

7) Vestibules:

Provide porcelain tile for the floor finish (integrate with floor mats, coordinate with current LEED requirements), porcelain tile base for the wall/floor trim, and painted wallboard for the wall finish. Provide suspended gypsum wall board or appropriate "feature" ceiling system with recessed or surface light fixtures for the ceiling finish and lighting format. The ceiling heights shall be 8'-0" above the finished floor.

8) Lobbies:

Provide porcelain tile for the floor finish (integrate with floor mats), porcelain tile base for the wall/floor trim, and painted wallboard for the wall finish. Provide suspended acoustic tile with recessed light fixtures in a typical grid pattern type exposed suspension system or a "feature" ceiling and light fixtures as appropriate. The ceiling heights shall be 9'-0" above the finished floor or as appropriate to integrate with the ceiling roof structure.

9) Corridors:

Provide porcelain tile and/or carpet tile for the floor finish (there is a wide range of flexibility provided for the corridors because there are so many possible variables in congregation type, local preference, and aesthetic coordination that may be true for any individual project), resilient base for the wall/floor trim, and painted wallboard for the wall finish. Provide suspended acoustic tile with recessed light fixtures in a typical grid pattern type exposed suspension system for the ceiling finish and lighting format. Unless otherwise noted, the ceiling heights shall be at least 8'-0" above the finished floor. Provide most corridors with a higher ceiling than that.

10) Stairways:

Provide raised pattern rubber tile for the floor finish (carpet tile with rubber nosing or porcelain tile are also acceptable where appropriate), resilient base for the wall/floor trim, raised pattern rubber treads, rubber riser and tread, and painted wallboard for the wall finish. Provide exposed ceilings and lighting for those portions where this would be appropriate. Provide suspended acoustic tile with recessed light fixtures in a typical grid pattern type exposed suspension system for the ceiling finish and lighting format where the upper portions of stairways transition into spaces with this finish treatment.

11) Storage Rooms:

Provide vinyl composition tile for the floor finish, resilient base for the wall/floor trim, and painted wallboard for the wall finish. Provide suspended acoustic tile with recessed light fixtures in a typical grid pattern type exposed suspension system for the ceiling finish and lighting format. The ceiling heights shall be 8'-0" above the finished floor.

12) Janitor's Closet:

Provide exposed concrete for the floor finish, resilient base for the wall/floor trim, and painted water-resistant wallboard for the wall finish. Provide suspended painted wallboard for the ceiling finish and lighting format. The ceiling height shall be 8'-0" above the finished floor.

13) Toilet Rooms:

Provide porcelain tile for the floor finish, porcelain tile base for the wall/floor trim, and painted wallboard with porcelain tile wainscots for the wall finish. Other decorative features, such as porcelain tile wall and floor patterns are also acceptable. Provide suspended painted wallboard for

the ceiling finish and lighting format. The ceiling heights shall be 8'-0" above the finished floor.

14) Equipment Rooms:

Provide exposed concrete for the floor finish, resilient base for the wall/floor trim, and painted wallboard for the wall finish. Provide suspended painted wallboard or exposed structure for the ceiling finish and lighting format. The ceiling height shall be as appropriate to the space and equipment.

15) Minimum Finish Requirements:

a) Carpet:

Provide carpet tile with commercial 100% branded (federally registered trademark) nylon continuous filament, permanent static control, loop pile with multi-color (geometric, bold, or floral patterns shall not be used), minimum finished yarn weight of 20 oz./sq. yd, 1/8" gauge minimum, minimum pile weight density of 4725, synthetic backing. Carpet tile installation shall be with release adhesive.

b) Porcelain Tile:

Porcelain tile shall conform to ANSI A137.1, have less than 0.5 percent water absorption and be a minimum commercial heavy traffic grade. Porcelain tile and trim shall be unglazed with the color extending uniformly through the body of the tile or glazed with body color consistent with glaze color. Note: in all places where porcelain tile are listed as requirements, locally available stone or similar other appropriate-for-the-use materials are also acceptable. Provide appropriate acoustical padding and installation techniques when the Worship Center has porcelain tile.

c) Vinyl Composition Tile:

Vinyl composition tile shall conform to ASTM F 1066, Class 2 (through pattern tile), Composition 1, asbestos-free and 1/8 inch thick, with color and pattern uniformly distributed through the thickness of the tile.

d) Raised Pattern Rubber Tile:

Rubber tile shall conform to ASTM F 1344, Class 1 homogeneous. Surface shall have a raised pattern, such as but not limited to, round or square studs.

e) Stair Treads, Risers and Stringers:

Treads, risers, and stringers shall conform to ASTM F 2169. Surface of treads shall have a raised pattern. Design shall be either a one piece nosing/tread/riser or a two piece nosing/tread with a matching coved riser. Installation shall include stringer angles on both the wall and banister sides and landing trim.

f) Wood Base, Cornice, Chair Rail and Other Wood Trim Items:

Shall be of same wood type, character and finish.

g) Resilient Base:

Base may be vinyl or rubber, 4 inches high and minimum of 1/8 inch thick.

h) Fabric Wall covering:

Fabric with acrylic backing shall be colorfast, stain, and soil resistant, and shall comply with NFPA 101 for textile wall materials. Wall covering shall be able to be cleaned by wiping, vacuuming or washing.

i) Vinyl Wall covering:

Vinyl wall covering shall be vinyl coated woven or nonwoven fabric, contain bactericides and mildew inhibitors and be Type II.

C. Interior Specialties:

1) Toilet Rooms:

a) Provide a completely integrated accessory set, shelves for hand-carried items and hooks for clothing. Provide child scaled features and fixtures in the children toilet rooms. Consider providing a counter with inset lavatories where individual wall mounted lavatories are shown.

b) Provide multiple robe hooks, a water resistant seat (inside the shower) and curtain rod for the shower in the single-person toilet.

c) Provide one pre-manufactured diaper changing unit for each of the public adult restrooms, Nursing Mother's Room, and Cry Room. The unit shall be wall mounted and designed to self-store up against the wall it is mounted on when not in the open position. Unit shall have safety features normally required for this type of unit. Depth in the closed position shall be 3".

2) Baptistry Suite Items:

Provide multiple robe hooks, a length of shelf, a water-controlling-slip-resisting floor mat, a water resistant seat and drapery and drapery hardware for each changing alcove.

3) Toddler Area Items:

Provide "cubbyhole" storage for parent provided child care items (unless local chaplains prefer to use a free-standing unit). Provide 10 heavy-duty ornamental wall hooks (coordinate height/location with local chaplains) to hang diaper bags, etc. up out of toddler reach but convenient for staff. Include a baby changing station and other appropriate features for the care of small children and their parent-provided supplies.

4) Nursery Area Items:

Provide "cubbyhole" storage for parent provided child care items. Include a baby changing station and other appropriate features for the care of small children and their parent-provided supplies.

5) Signage:

Provide a complete interior signage system that coordinates with the interior design. The facility interior signage system shall be standardized throughout the building and shall be flexible to allow for the addition and deletion of signs and information. Room signs and building directories shall be provided. Room signs for spaces in which the room name, function of the room, or personnel within a room may change shall have a changeable paper insert that can be changed by the User in the future. This applies to rooms such as offices, classrooms, multi-purpose rooms, nursing mother's room, resource center, meditation and reconciliation, sacrament chapel, etc. Coordinate rooms to have changeable inserts with the User. Provide restroom signage with easily changeable

inserts/panels so that they may be assigned to either men or women depending upon specific building user characteristics. Directories shall be located in both primary lobbies and at a minimum shall identify the location of the Worship Center, Administrative Suite, Restrooms, and Multi-Purpose Rooms.

6) Window Treatment:

Provide devices to fully block natural light from entering the Worship Center and Activity Center. All other exterior windows shall have horizontal blinds, with the exception of windows at building entrances. Blinds in Multi-Purpose rooms shall be room darkening. Ornamental drapery (dossal) in Worship Center shall be lined and conceal the view of baptistery when not in use and shall not obscure the view of baptismal pool when in the open position. Drapery shall also be provided within the Baptistery Suite at the entries to the changing booths. Drapery fabric within the Baptistery Suite shall be resistant to damage from repeated contact with water. Drapery fabric, fabrication, and hardware shall be appropriate for the intended use and location.

7) Marker Boards:

Provide one marker board in the kitchen and the Administrative Group Office. Marker boards shall be wall mounted with a marker tray. Dry erase markings on marker board shall be removable with a felt eraser or dry cloth. Marker board size shall be 4'-0" w x 3'-0" h.

8) Presentation Boards:

Provide one presentation board in each Multi-purpose Room. Presentation board shall be of the wall hung wood cabinet type with doors. Inside there shall be a marker board writing surface with marker tray and projection screen. Presentation board size shall be 4'-0" w x 3'-0" h.

9) Entry Mats:

Provide entry mats at all entry vestibules and lobbies. Entry mats shall be of the shallow built-in type, classified for heavy commercial use and of dirt-hiding construction.

10) Hardwood Benches:

Provide one built-in maple or hardwood bench (special recycled material units are also acceptable) with moisture resistant finish in each Baptismal Suite changing booth. Size shall be 1'-6" d x 1'-6" h x length to fit the space.

11) Diaper Changing Units:

Provide one pre-manufactured unit specifically designed for diaper changing for each of the group restrooms. The unit shall be wall mounted and designed to self-store up against the wall it is mounted on when not in the open position. Unit shall have safety features normally required for this type of unit. Depth in the closed position shall be 3".

12) Range Hoods:

Provide range hoods at ranges. Range hoods shall be designed to vent away fumes from food being heated or reheated. Units shall include control switches for selection/adjustment of functions and fan speed. A variety of additional options are available, as are a range of quality and performance characteristics. Locate above range in kitchen.

13) Adjustable TV Wall Mounts:

Provide one adjustable TV wall mount for flat screen TV in each primary Lobby and Multi-

purpose Room (and possibly in numerous additional rooms; coordinate with the Garrison). Contact local suppliers for advice on selection. Coordinate with TVs being purchased as much as possible, but provide a relatively universally designed product so that the TV may be changed out over time. Wall mount shall have the ability to adjust for tilt, angle, horizontal and vertical placement of TV screen.

14) Adjustable Media Player Mounts:

Provide one adjustable media player wall mount in each Multi-purpose Room. Contact local suppliers for advice on selection. Coordinate with media players being purchased as much as possible, but provide a relatively universally designed product so that the players may be changed out over time. Wall mount shall have the ability to adjust in relation to the TV screen.

15) Fire Extinguisher Cabinets:

Provide fire extinguisher cabinets where fire extinguishers are required by UFC 3-600-01, NFPA 10, and NFPA 101. Provide semi-recessed cabinets in all finished areas. Fire extinguisher cabinets shall be capable of housing a 10 lb ABC portable fire extinguisher. Fire extinguisher door panels shall not be locked.

16) Paper Towel Dispenser and Soap Dispenser

Provide paper Towel Dispensers and Soap Dispensers where lavatories and sinks are provided, excluding utility sinks.

3.6 STRUCTURAL REQUIREMENTS:

A. General:

Column locations and sizes shown on the architectural floor plan are based on a pre-engineered metal building superstructure design condition. Although this has been assumed for the Army Standard Design, a wide variety of structural systems may prove suitable for this facility. The design of structural systems shall be based upon applicable criteria. The foundation system shall be designed according to site specific soil conditions which will require a geotechnical site investigation. The local availability of building materials may be the deciding factor on the type of structural systems chosen. The longer than normal spans in the large seating areas is an aspect of the design that must be given careful consideration. Structural features shown on the Army Standard Design drawings try to reflect a sense for how the structure may function. However, they are not based upon a full design and are essentially arbitrary. Any project design is certain to vary from what is shown. Variations to the structural features will in turn cause slight variations in the spaces they enclose. Such variations are expected and do not imply failure to comply with the Army Standard Design.

B. Design Loads:

1) Live Loads:

Live loads (including floor and roof live loads, snow loads, wind loads and seismic loads) shall be as specified in the most recent edition of the International Building Code (IBC).

2) Dead Loads:

Dead loads shall consist of the weight of all materials of construction incorporated into the building including but not limited to walls, floors, roofs, ceilings, stairways, built-in partitions, finishes, cladding and other similarly incorporated architectural and structural items, and fixed service equipment including the weight of cranes.

3) AT/FP Requirements:

UFC 4-010-01 provides guidance on project planning in conjunction with establishing standoff distances for buildings to parking, roadways, trash containers and Garrison perimeters. Minimum standoff distances cannot be encroached upon. These setbacks will establish the maximum buildable area. All standards in Appendix B of UFC 4-010-01 (9 February 2012) must be followed. In addition to the UFC cited in this paragraph UFC 4-020-02FA, (2005) Security Engineering: Concept Design; UFC 4-020-03FA, (2005) Security Engineering: Final Design; UFC 4-020-04FA, (2005) Electronic Security Systems: Security Engineering; and UFC 4-021-01, (9 April 2008) Mass Notification Systems also apply to the facility. The Large Chapel Army Standard Design facilities meet the requirements of this paragraph provided the minimum standoff distances are achieved.

4) Foundation/Slabs-on-Grade:

The foundation system shall be designed according to site specific soil conditions which will require a geotechnical site investigation. Provide structural stoops at exterior doors with foundations designed to prevent heave or settlement.

5) Construction Materials:

The local availability of building materials may be the deciding factor on the type of structural systems chosen.

6) Design Analysis:

The Design Analysis shall include lists of design criteria, structural design loads, structural materials with stress grades and/or ASTM designations, and calculations. A copy of the Foundation Analysis shall be included as an appendix to the Design Analysis.

C. Modification To Existing Structures:

Structural requirements for modifications to existing structures shall comply with IBC 2006 Chapter 34 Existing Structures. Implementation AT/FP requirements of UFC 4-010-01 (9 February 2012) is mandatory for existing buildings when triggered by UFC 4-010-01 paragraph 1-8.2 Existing Buildings.

3.7 SEE PARAGRAPH 6.7 THERMAL PERFORMANCE – NOT USED

3.8 PLUMBING REQUIREMENTS:

A. General:

Provide appropriate underground and aboveground domestic water supply (hot and cold), storm, sanitary sewers and natural gas distribution systems. Toilet facilities, kitchen facilities and floor drains make up the majority of the plumbing requirements in this facility. Provide a below sink garbage disposal for one side of each kitchen sink. Provide drainage for each of the spaces in the Baptistery Suite to accommodate the water that drains off of persons after they depart from the Baptismal pool. Provide a special sink with a drain extended to the ground for the Sacarium.

B. Domestic Water:

Domestic hot water for the Kitchen and various sinks, and showers shall be provided. Domestic water heating system shall comply with the requirements of the Energy Independence and Security Act of 2007 with respect to the use of solar water heating.

C. Plumbing Fixtures:

Provide “WaterSense” certified plumbing fixtures where available. Starting in FY14 all buildings plumbing systems will be required to have a maximum of 0.025% lead in the fixtures and piping.

D. Gas Piping:

Gas should be utilized where feasible and available as main source of heating for domestic water heaters.

3.9 COMMUNICATIONS AND SECURITY SYSTEMS:

A. AV System:

1) General Audio/Visual (AV) System:

Provide a complete A/V System design and provide and install supporting raceway system in construction. The A/V system design shall include a complete component list with brands, models, pricing, and a detailed functional description of how the system is intended to operate. Private sector or other designers (for design-bid-build contracts) provide essentially the same thing, but within the format limitations required by this different contract form. For example, specifications may include generic information instead of specific makes and models. The specific details of this will be provided when specific projects are initiated for design. This A/V system shall be a high quality, fully integrated audio-visual system for the facility that allows for all currently common media activities including the ability to integrate media, private and commercial television broadcasts. The system shall have some ability to be controlled by portable computer. The system may consist of component sub-systems, so long as all are fully integrated for operation throughout the facility. The system shall have the ability to transmit separate media to the Worship Center, Activity Center and each Multi-Purpose Room. The system shall also have the ability to allow the Worship Center, Activity Center, and Baptistery Suite to function together and share a single media presentation.

2) AV System Control:

a) The “primary” control point for the A/V system shall be located in the Worship Center in a CFCI lockable media control console at the front of the Worship Center balcony, fully set up to control all media items and equipment. Contractor shall coordinate with the end user to ensure the media control console is appropriately sized for all equipment. Contractor shall provide additional secondary control points for the A/V system in the following locations:

(1) In the Worship Center:

(a) At the pulpit area

(b) At one of the two positions indicated on either side of the raised platform

(c) Along the sidewall toward the Primary Entry Lobby

(2) In the Activity Center:

(a) At one side of where the portable raised platform is shown

(b) Along the sidewall toward the Primary Lobby.

(3) In the Multi-Purpose Rooms

(a) Along one sidewall.

b) All secondary control points shall have basic control functions for on/off/volume-of-each-speaker-grouping-in-the-space/microphone-on-off. Each secondary control point shall also have inputs points for a portable type computer and television quality camera. In rooms with operable projector mounts, the secondary control shall be able to raise and lower each projector. Each secondary control point shall have a lockable cover and be integrated into the supporting features. The control housing at the Worship Center raised platform shall be supported by a quality furniture cabinet or table.

3) AV System Input:

The system shall be able to process input from all microphones, musical instruments as defined, portable computers, and television cameras. Provide connections/accommodations for wired and wireless, hand-held, mounted, lapel clip and belt clip types of microphones. The contractor shall provide a minimum of 12 plug-in type microphone connection points along the middle and rear edge of the raised platform in the Worship Center. Provide a hanging microphone array (or input connections to support these or other high quality means) to transmit the choir. A permanently mounted camera, microphone boom, and microphone or hanging microphone (both relatively out of sight) shall be installed for the baptismal pool to safely and accurately pick up the view and voices of people in the baptismal pool. The contractor shall provide a minimum of 3 plug-in type microphone connection points evenly distributed in each multi-purpose room. The contractor shall provide a booster device (if needed) to accommodate wireless microphone input to the A/V system from the Primary Entry Canopy Area. Contractor shall also provide CATV input to the A/V system.

4) AV System Output:

The system shall include a low-level distribution loudspeaker system that provides uniformity of coverage between the frequencies of 100-12,000 Hertz. The system shall be capable of producing an intelligible signal at a minimum of 75 dB throughout the spaces. Speakers may be wall and/or ceiling mounted. Major speaker arrays in the larger spaces shall be mounted behind visual screens or on shelves with "parapet walls" so that they are out of sight for those people in pews. Speakers shall also have volume-on-off control. Contractor may install volume control at each speaker, or have one control per room. Speaker arrays shall be designed for and located in the following rooms: Worship Area, Multi-purpose rooms, Offices, Changing Booths, Baptismal Suite Corridor Stairway, Kitchen, Pantries, Sacristy/Robing Room, Lobbies, Entry Canopy Areas, and Restrooms.

5) AV System Projectors:

The system shall include LCD projectors. The Worship Area shall have three (3) permanently mounted LCD projectors on fixed projector mounts facing the screens in this area. Each Multi-Purpose room shall have one (1) permanently mounted LCD projector on an operable projector mount that allows for raising and lowering of the projector unless the local customer representatives make the decision to use flat-screen TV technology to accomplish this same goal.

6) AV System Certifications:

The system shall be National Systems Contractors Association (NSCA) certified with R-ESI credentials for the system coordinator and C-EST credentials for the installing staff.

B. Telecommunication Systems:

1) Community antenna Television (CATV):

A CATV system shall be installed in accordance with the Technical Guide for Installation Information Infrastructure Architecture (I3A). A minimum of one (1) CATV outlet shall be located in the following rooms: offices, and multi-purpose rooms. A minimum of three (3) CATV outlets shall be distributed along the raised platform in the Worship Center.

2) Telephone and Data:

Telephone and data outlets shall be installed in accordance with the Technical Guide for Installation Information Infrastructure Architecture (I3A), with the following exceptions. All offices shall have a minimum two (2) combination telephone and data outlets available for workstations. The "Group Office" shall have a minimum four (4) combination telephone and data outlets available for workstations. The multi-purpose rooms shall have a minimum six (6) combination telephone and data outlets available for workstations. The Kitchen and Sacristy/Robing shall each have a minimum of one (1) combination telephone and data outlet.

3) Public Address (PA) System:

The contractor shall make provisions to connect the phones to the A/V system audio for use as a PA system.

Not Used

3.10 ELECTRICAL REQUIREMENTS:

A. General:

Lighting for this facility shall be according to all applicable criteria and shall take into consideration the functional needs of the spaces. This, along with fans and fractional horsepower motors, will make up the majority of the electrical loads for the facility.

B. Lighting Requirements:

Lighting for most spaces with suspended acoustic ceilings shall be of the recessed type. Lighting for the Worship Center shall receive special attention as to color accents in lighting, fixture type, and flexibility. Creative lighting techniques are encouraged. High lighting shall include some accommodation for maintenance and the changing of lamps. Some past chapel projects have made very successful use of light fixtures that can be lowered to the main floor level for maintenance. While keeping the operating hardware secure is important, these system should provide automatic lowering to floor level and raising to ceiling height without manually holding a key for the entire process. Address how light fixtures in high-above-the-floor locations will be maintained when this ASD is applied to a specific project. A dimming system shall be installed to control the Worship Center. The dimming system shall be capable of controlling lighting down to 5%, a minimum 3 presets, and manual raising/lowering of the light levels. All illumination levels shall be maintained illumination levels per IESNA recommendations.

C. Power:

1) Mechanical Equipment:

Requirements for heating, ventilation, and air conditioning system shall be determined by the project criteria package. Heating, ventilation, and air conditioning system may be distributed into several smaller units throughout the building because of difficulty in running duct systems through

the building. Mechanical and Electrical rooms shall be separate. Each room shall have exterior access. Mechanical / Electrical rooms are not to be used for any other purpose unless agreed to by the appropriate mechanical / electrical designers. All exterior on-grade mechanical and electrical equipment shall be located within an enclosed area. Access around equipment shall be provided for service and air flow. In cold climates provide features that will protect plumbing, water lines, and other lines from freezing.

2) Support Facilities:

Full-Immersion Baptistry will require power to run a circulating pump, heater, and automatic valve shut-off or alarm when the pool has reached full capacity. No other power except lighting will be allowed in the Baptistry Alcove. Baptistry adjacent changing rooms will require exhaust fans and GFI receptacles for hair dryers. Raised Platforms will require recessed power outlets and outlets for wired microphones. Power outlets and microphone outlets will be located in close proximity to give the maximum amount of flexibility. Provide the main lobby with power and communications support for a movable kiosk (reception/information desk) at two points (one is suggested in the drawings) in the lobby. Provide the main lobby theme kiosk (as shown) with suitable power and communications support. Provide the Activity Center theme kiosk with suitable power and communications support.

3) Miscellaneous Equipment:

Provide power for all equipment that is identified in this document. This equipment includes, but is not limited to, ranges with ovens, warming drawers, full size refrigerators, stand-alone ice-makers, automatic dishwashers, garbage disposals, and microwaves in the kitchen, and an under-counter refrigerator in the sacristy.

4) Kitchen:

Countertop outlets shall be provided per NEC 210.52 for kitchens. Countertop outlets shall be served by a minimum of 3 circuits. The design ideal/intent is to provide many outlets very close together to support an entire "fleet" of crock-pots, coffee-pots, warming dishes, etc.; all filled with pre-prepared food items that congregation members have brought in for a really large "pot-luck" event. The same is true for a center island in the kitchen. If the local customer representatives strongly desire a commercial grade piece of equipment (not at all intended or recommended by the Office of the Chief of Chaplains), provide these with the increased amount of power necessary for operation.

3.11 HEATING VENTILATING AND AIR CONDITIONING (HVAC) REQUIREMENTS:

A. General:

1) The facility shall normally be heated and air-conditioned except that the storage and service areas may be ventilated and heated as required by code. The Kitchen shall be cooled not to exceed 85 degrees Fahrenheit and heated to maintain temperature no less than 68 degrees Fahrenheit. The janitor closet and restrooms shall be maintained at a negative pressure relative to adjacent areas. Mechanical rooms shall accommodate space for equipment maintenance access without having to remove other equipment. Mechanical, electrical and telecommunications rooms shall be keyed separately for access by Garrison maintenance personnel and fire department.

2) With the exception of exhaust fan dedicated for restrooms and janitor closet or air cooled equipment, all primary equipment of the HVAC, and plumbing system(s) shall be located in the mechanical equipment room. This includes equipment such as air handling units, dedicated outside air system units, energy recovery units, pumps, central water heaters and water-to-water heat pumps. Air tempering equipment dedicated to provide zone control to different essential areas should typically be located in proximity to the areas served. This includes equipment such

as variable air volume boxes, and water-to-air heat pumps. Accessibility for future maintenance to the mechanical equipment shall be taken in account in the design, selection and location of all mechanical equipment. Intake, relief and exhaust louvers shall be provided at the exterior of the building. Each louver shall be provided with a 2-position, parallel blade isolation damper located at or near the louver. Additional modulating flow control damper(s) shall be provided as required by the system equipment and control sequence.

B. HVAC Design:

The Heating, Ventilating, and Air Conditioning system(s) shall be based on geographical location, climate and applicable criteria listed in this document.

C. Mechanical Systems Selection:

Selection of energy sources and mechanical system(s) shall be based on local availability, energy consumption, maintainability, reliability and life cycle cost. In addition, all mechanical system(s) design and selection(s) shall comply with the requirements of applicable criteria listed in this document.

D. Concealed Elements:

Conceal all mechanical systems, including the ductwork, in occupied spaces. Coordinate such that concealed shafts or pathways are provided where mechanical system(s) require them. Outdoor intake and relief or return louvers shall be designed in such a way that general public access to these components is restricted. Heating, ventilating, and air conditioning (HVAC) control system shall be easily accessed by staff, but relatively secure from the general public

E. Zoning:

Provide carefully considered zoning to accommodate the optimum number of use combinations. Interior spaces should typically be in separate zones from exterior spaces. Zones separation shall be also based on systems isolation and operation. Air handling system serving the Worship and Activity Center requires individual zone control. Areas such as the Classrooms and Multi-purpose Rooms shall be served by systems that will provide individual temperature control in each space and should provide for economy of operation when only a few of these spaces are occupied. Air distribution systems may include, but are not limited to, systems such as variable air volume, fan coil units, water-to-air heat pumps and variable refrigerant flow systems.

F. HVAC Control System:

This facility will be used in many different ways. Some spaces will be filled to capacity at the same time that other spaces will be empty. Provide a direct digital control (DDC) system for control of the heating, ventilating, and air conditioning system equipment. The control system shall provide automatic operation of the HVAC equipment, but shall also allow for override of system programming in order to accommodate varied uses of the facility. For spaces where the number of occupants varies from just a few to a large number (such as the Worship Center), consideration should be given to the use of CO2 sensors to control the volume of outside air supplied to the space, based on the actual need in lieu of constantly supplying the volume of outside air required for maximum occupancy during all occupied hours. Provide densely-populated rooms (as defined by codes or LEED) with CO2 sensors to control the volume of outside air supplied to the space. Outside air should not be supplied to spaces during unoccupied periods or when spaces are in the warm-up or cool-down mode prior to occupancy. The requirement for integration into a Garrison-wide EMCS shall be investigated and appropriate provisions made. Integration of the building HVAC control system into the Garrison-wide EMCS shall be provided unless specific guidance is provided to the contrary.

G. ACOUSTICS:

Acoustics is an important consideration in the design of chapels. Provide mechanical equipment items placed outside and adjacent to the building with screening and appropriate acoustic control. Also, ensure that operating noises do not intrude into inhabited areas. Designer shall design the air distribution system(s) to be less than or equal to 20 NC. Access clearances for servicing and proper airflow shall be provided when developing the screening and acoustic control of equipment located outside the building.

3.12 ENERGY CONSERVATION REQUIREMENTS:

A. General:

- 1) Provide all appropriate energy conservation features. Coordinate issues such as siting, sustainability, and meeting all energy conservation requirements listed in other sections.
- 2) Mandated federal criteria are regularly being revised to decrease such energy consumption by increasing energy efficiency. Documents, such as ASHRAE 189.1-2009, have been developed to focus building design on steadily improving their levels of energy efficiency.
- 3) An energy analysis for the Chapels was performed in accordance with ECB Number 2010-14 (28 June 2010), ECB Number 2011-1 (19 January 2011), and the U. S. Department of Energy (DOE) guidance issued in the Federal Register (NARA 2006) which states that savings calculations should not include “plug loads” (process loads) and implies that savings shall be determined through energy reduction cost savings. The energy analysis showed that this facility could meet the targeted energy reduction goals of ECB 2010-14. The target was 40% actual energy reduction from the base-line energy use defined in the criteria of ASHRAE 90.1-2007.
- 4) As a result of this energy analysis, it is recommended that facilities provided for climate zones 1a & b, 2a & b and 3a, b & c have horizontal shades above the windows, shading grills, or other devices or building geometry (like being deeply recessed) techniques (clerestories close to the roof line may accomplish the same benefit with overhangs) to allow for meeting the required energy reduction savings.
- 5) ECB 2012-13 has been issued since the energy analysis was conducted. This document states that when applying ASHRAE Standard 189.1 energy performance standards, ensure that the minimum energy savings to be achieved, through performance or prescriptive paths, is at least 30 percent better than ASHRAE Standard 90.1-2007 (including process and plug loads). The U. S. Army has decided to include/use site energy for the HVAC, lighting, and hot water loads to determine the energy savings. The previously conducted energy analysis results meet the minimum levels outlined by this new ECB.
- 6) It is assumed that both the governing criteria and the energy target (as defined by the U. S. Government and organizations such as the United States Green Building Council (USGBC)) will change regularly. Provide every facility (these will generally be projects appropriated at specific times over several years) so that it meets the requirements of governing criteria and the energy target that are applicable at the time of project development.
- 7) Many federally mandated definitions/requirements or measures of energy consumption criteria (energy reduction cost savings) are not identical with other measures of energy efficiency or sustainability. Examples of different measures are those described in the USGBC “LEED” point criteria.
- 8) Provide a comprehensive analysis of energy consumption during specific project design processes and incorporate what appears to be the best/most-appropriate blend of features/characteristics that will reduce energy consumption of the facility to the minimum

practicable levels. Also meet whatever the current mandates or criteria that apply at the time of the specific project under design.

3.13 FIRE PROTECTION REQUIREMENTS:

A. General:

1) Standards and Codes:

Provide fire protection and life safety features in accordance with UFC 3-600-01 and the criteria referenced therein.

2) Qualifications:

The Fire Protection Engineer (FPE) shall meet one of the conditions indicated in the UFC 3-600-01 and shall be part of the design team. Submit qualifications and credentials of the FPE at the start of the project. The FPE shall provide a letter at the completion of the design certifying the project meets UFC 3-600-01 and applicable codes. Fire Protection Engineer shall be responsible for all aspects of the life safety, fire sprinkler, and fire alarm systems for each facility. Fire Protection Engineer is responsible to provide the life safety and fire protection analysis.

3) Fire Protection and Life Safety Analysis:

Provide a fire protection, building code and life safety analysis for all buildings in this project. This analysis shall be submitted in accordance with the provision described in section 01 33 00 Submittal Procedures and UFC 3-600-01. Provide an analysis per UFC 3-600-01 for each facility.

B. Fire Suppression Systems:

1) Sprinkler System:

Provide complete sprinkler protection in accordance with UFC 3-600-01. Sprinkler protection shall be designed in accordance with UFC 3-600-01. Wet pipe sprinkler systems shall be provided in all heated areas and dry pipes sprinkler systems shall be provided in areas subject to freezing. Provide a hydrant flow test at the site prior to starting the fire protection design. It is preferred to provide a fire sprinkler system without a fire pump. Refer to Paragraph 8.

2) Sprinkler Service Main and Riser:

Sprinkler service mains shall be dedicated lines from the distribution main. Do not combine sprinkler service piping and domestic service piping. Sprinkler service mains shall be provided with an exterior post indicating valve with tamper switch reporting to the fire alarm control panel (FACP) inside of each building. Underground fire service pipe penetrating floors shall be provided with a pipe sleeve. The sprinkler riser shall include a double check type backflow preventer, a fire department connection and an exterior wall test connection for testing of backflow prevention assembly. The sprinkler system shall include an indicating control valve for each sprinkler riser, a flow switch reporting to the FACP, and an exterior horn and strobe at the location of the fire department connection. Each floor shall be provided with a separate control valve with tamper switch and flow switch. Coordinate with the local base fire department to determine the exact exterior notification appliance they prefer such as water gong, horn and strobe, etc.

3) Backflow Preventer:

Provide a double check valve assembly for all fire sprinkler water supplies. An exterior flush wall test connection with dual hose connections with OS&Y valve shall be provided to allow testing of

the backflow preventer. Provide sign that says "Test Connection."

4) Fire Department Connection:

A fire department connection shall be provided for each building provided with a suppression (sprinkler) system. The location shall be accessible by the fire department, shall be unobstructed, and shall be within 150 feet from the nearest fire hydrant. Coordinate with the local base fire department whether they prefer a free-standing connection versus a wall mounted connection. Fire Department Connections shall generally be placed on the address side of the building where Fire Department Personnel will be entering the building.

5) Fire Pump:

The requirement for a fire pump shall be determined by the Contractor based on hydrant fire flow data from the project site and fire protection system design for the project. If required, a complete fire pump design and installation shall be provided for the facility. Fire pump design and installation shall comply with the requirements of UFC 3-600-01 AND NFPA 20. It is preferred to design and provide a fire sprinkler system without a fire pump.

6) Sprinkler System Materials and Components:

Materials and components for sprinkler systems and fire pumps shall be in accordance with UFC 3-600-01, NFPA 13 and NFPA 20. Sprinkler head type shall be quick response (wet pipe system only). Piping shall not be exposed in finished areas.

7) Area of Demand, Design Density, and Exterior Hose Stream:

Area of demand, design densities and exterior hose stream shall be in accordance with UFC 3-600-01, Table 4-1.

8) Fire Water Supply:

Provide fire hydrant flow test(s) at the site prior to any design. Any flow data provided in the Appendix is for information only and not to be used to develop the fire protection design. Provide a water supply analysis per UFC 3-600-01 as part of the design to determine whether there is adequate water supply and duration for the project. Provide hydrants as required per UFC 3-600-01, and NFPA 1.

9) Kitchen:

Because the facility is a Place-of-Assembly, provide an appropriate form of fire suppression equipment for the ranges. If the local customer representatives strongly desire a commercial grade piece of equipment (not at all intended or recommended by the Office of the Chief of Chaplains), provide these with a commercial kitchen hood and wet chemical suppression system and automatic shut-off for electric or gas fuel sources per NFPA 96 and 90A. Design shall conform to UFC-3-600-01. If the local customer representatives select residential grade pieces of equipment (the ideal/intent of this ASD), a residential hood may be provided.

10) Fire Extinguishers:

Travel distance to/from the extinguisher cabinets shall not exceed that required by NFPA 10. Fire extinguisher cabinets shall be capable of housing a 10 lb ABC portable fire extinguisher. Fire extinguisher door panels shall not be locked. Fire extinguishers are to be provided as part of the project.

C. Fire Detection And Alarm Systems:

Provide an addressable type fire alarm system with addressable devices per NFPA 72, UFC 3-600-01, and UFC 4-021-01. Type, function and location of the fire alarm annunciation panel shall be coordinated with the local Authority Having Jurisdiction (AHJ). For additional information, refer to Electrical and Communication paragraphs in this section. Fire Alarm and Mass Notification Systems shall be controlled from a single panel. Coordinate with local base fire department for the type and style of the fire alarm system as well as the monitoring and reporting equipment.

D. Mass Notification:

Provide a mass notification system designed in accordance with UFC-4-021-01.

3.14 SUSTAINABLE DESIGN:

A. Many features that make a facility sustainable can be integrated into a typical building and site. Reduction in the use of water is a key element that generally applies to every building and site. However, other very beneficial features/techniques (such as shading devices for buildings or building orientation for sites) or materials might also have application but need to have a more tailored building and site to be effective.

B. The offerer (for design-build contracts) or designer (for design-bid-build contracts) is encouraged to suggest sustainable material substitutions or building feature modifications for consideration where they appear to provide benefit without appearing to interfere with functionality.

C. See Paragraph 6.14 for additional Sustainable Design guidance.

3.15 SEE PARAGRAPH 6.15 ENVIRONMENTAL DESIGN – NOT USED

3.16 SEE PARAGRAPH 6.16 PERMITS – NOT USED

3.17 SEE PARAGRAPH 6.17 DEMOLITION – NOT USED

3.18 SEE PARAGRAPH 6.18 ADDITIONAL FACILITIES – NOT USED

3.19 EQUIPMENT AND FURNITURE REQUIREMENTS:

A. General:

The criteria within this document identifies the level of quality and special requirements for furniture and equipment, yet provides flexibility for the designer to make creative and appropriate selections to meet User requirements. Furniture and equipment shall be complementary and compatible with the building design and provide a completely coordinated interior design. Unless otherwise noted, items in this section shall be Government Furnished/Government Installed (GF/GI); also refer to Section 01 10 00, paragraph 6. Dimensions provided are approximate.

3.19.1 Furnishings:

A. General:

Furniture shall not have sharp edges. Clips, screws, and other furniture construction elements shall be concealed where possible. Upholstery for office areas, lounge furniture and stacking seating shall meet Wyzenbeek Abrasion Test, 55,000 minimum double rubs. Furniture style details and finishes shall be compatible throughout the facility and coordinated within a room. Furniture finishes and fabrics shall be appropriate for intended use. Upholstery fabric (color, pattern and fiber content) shall be easily cleaned and help hide soiling. Provide patterned fabrics for seating to help hide soiling. Upholstered stacking seating fabric shall have a soil retardant finish to aid in cleaning and maintenance.

B. Accessories:

- 1) **A01 - Small Trash Receptacle:** Small trash receptacle, minimum 28 quart capacity. Size 1'-2''w x 10'd x 1'-3''h.
- 2) **A02 - Large Trash Receptacle:** Large trash receptacle, minimum 12 gallon capacity. Size 1'-3'' in diameter x 2'-9''h.
- 3) **A03 - Paper Recycle Receptacle:** Small paper recycle trash receptacle, minimum 28 quart capacity. Size 1'-2''w x 10'd x 1'-3''h.
- 4) **A04 - Toilet Receptacle:** When built-in-to-the-partition trash receptacles are not included in the design, provide free-standing toilet receptacles of an appropriate capacity, material, and finish. Coordinate the specific receptacle selected with the local chaplains.

C. Desks And Storage:

Furniture can be wood, plastic laminate or metal finish, coordinate finish material with the User. Preferred top for wood furniture is plastic laminate that closely matches adjacent wood with mitered solid wood edge. Glass tops shall be provided for furniture with wood tops. Tops for case goods with plastic laminate or metal construction shall be plastic laminate. Location, use, and frequency of moving furniture shall be considered when determining appropriate finish material and construction. Furniture constructed of particleboard with plastic laminate finish is not acceptable. Plastic laminate shall be high pressure plastic laminate, not low pressure plastic laminate. Box and file drawers shall have a heavy-duty suspension system. Furniture shall be constructed with concealed fasteners. Furniture storage shall be lockable. Verify with User if keyboard trays are required at desks; many Users prefer not to have keyboard trays since laptops are used. Recommend full modesty panel at primary work surface between personnel and guest. If provided at building walls, modesty panel shall allow access to wall electrical and data outlets. Provide for the following Desk and Storage Items:

- 1) **D01: Not Used**
- 2) **D02 - U-Shaped Workstation with Left Return:** Workstation shall have a primary work surface with a pencil drawer and pedestal; desk height bridge with adjustable keyboard tray and mouse attachment; and secondary work surface with pedestal. Unit shall also have overhead storage, tackboard, and task light under all overhead storage, and modesty panels. Storage shall be lockable. The size of the primary work surface shall be 6'-0''w x 2'-6''d. The size of the bridge shall be 3'-6''w x 2'-0''d. The size of the secondary work surface shall be 6'-0''w x 2'-0''d. The work surface height shall be 2'-6''.
- 3) **D03 - Administrative Workstation:** Administrative workstations with primary work surface with a pedestal; a desk height return with adjustable keyboard tray and mouse attachment; and a secondary work surface with pedestal. Storage shall be lockable. If space allows, unit shall also have lockable overhead storage, tackboard, and task light under all overhead storage, modesty panels and pencil drawer. The size of the primary work surface shall be 5-feet-10-inches wide x 2-feet-6-inches deep, of the return shall be 3-feet-5-inches wide x 2-feet deep, of the secondary work surface shall be 5-feet-10-inches wide x 1-feet-8-inches deep, the work surface height shall be 2-feet-5-inches, for the Group Office, coordinate requirement for "transaction" surface with customer.
- 4) **D04 - Bookcase:** Five-shelf bookcase with 4 adjustable shelves. 3-feet wide x 1-feet-3-inches deep x 5-feet-6-inches high. Bookcases/shelving in Resource Center shall be deep enough to store required materials and supplies.
- 5) **DO5 and DO6: Not Used**

6) **D07: Not Used**

7) **D08: Not Used**

8) **D09: Not Used**

9) **D10 - Lateral File with Shelving:** Storage with two lateral file drawers below and adjustable shelving above. Size 2'-6"w x 24"d.

D. Seating:

1) **S01 - Desk Chair:** Ergonomic desk chair with adjustable arms, separate upholstered cushioned seat and back, back tilt and locking capability, pneumatic seat height adjustment, back height adjustment, seat depth adjustment, five star base on casters. Size 2'-0"w x 2'-2"d x 2'-8" to 3'-2"h. Verify that seat height is appropriate for casework height and kiosks, and make changes as necessary.

2) **S02: Not Used**

3) **S03 - Guest Chair:** Guest chair with arms and upholstered cushioned seat and back. Wood back is also acceptable. Style shall complement the desks and desk chairs. Size 1'-9"w x 1'-11"d x 2'-6"h.

4) **S04 - Lounge Chair:** Fully upholstered lounge chair with enclosed arms. Armrests and legs/base may be wood, frame shall be solid hardwood with all parts glued and fastened. Size 2'-7"w x 2'-7"d x 2'-9"h.

5) **S05: Not Used**

6) **S06 - Stacking Chair:** Sled base stacking chair with upholstered seat and back shall stack a minimum of 10 on dolly and a minimum of 6 on floor, with glides. Glides shall be appropriate for floor finish. Frame shall be solid base stock with chrome plate or durable color finish. Approximately 40% of the seating located in the Activity Center shall be able to be stored in the adjacent storage room. Size 1'-7"w x 1'-11"d x 2'-7"h for the back and 1'-6" for the seat.

7) **S07 - Stacking Chair Dolly:** Dolly shall stack 10 S06 chairs and shall fit through single wide door with stacked chairs.

8) **S08 - S09: Not Used**

9) **S10: Not Used**

10) **S11: Not Used**

11) **S12: Not Used**

E. Tables:

1) **T01 - Multi-Purpose Table, 72" x 30":** Tables shall be designed for heavy use, be adjustable in height, and have folding legs with automatic locking leg feature. Table shall be lightweight and tabletop shall be easily cleaned and maintained (ABS plastic is an excellent choice; other choices are usually too heavy)). All working parts shall be recessed behind an apron. Top surface and edge treatment shall withstand heavy use. Size shall be 6'-0" long x 2'-6"d x 1'-8"h to adjust to 2'-6"h.

2) **T02: Not Used**

3) **T03 - Table Dolly, 72" x 30"**: Dolly type, size and quantity shall transport and store all of the T01 tables. Fully loaded dolly shall be capable of being maneuvered within the facility, fit through a singlewide door. Provide quantity to store all folding tables.

4) **T04 - Lobby End Table**: Detailing and finish to match seating and other furnishings in room. Recommend a plastic laminate tabletop that can be easily cleaned and maintained. Size shall be 1'-11" w by 1'-11" d x 1'-10" h.

5) **T05: Not Used**

6) **T06: Not Used**

7) **T24: Not Used**

8) **T25: Not Used**

3.19.2 Equipment:

A. Miscellaneous Items:

1) **M01 - Portable Podium**: Movable stand-up lectern, adjustable height shelf and angled reading shelf with pen rail to prevent items from sliding off shelf.

2) **M02 - Medium Equipment Cart**: Three shelf mobile cart. Size appropriately for TV size. Consider lockable cabinet for additional storage and/or TV.

3) **M03 - Small Equipment Cart**: Mobile Cart for audiovisual equipment. Size appropriately for equipment requirements.

4) **M04 - Organ**: Electronic organ with bench to be appropriately sized for the number of seats in the Worship center. Also provide a dolly for moving the organ. Contact local suppliers for advice on selection.

5) **M05 - Grand Piano**: Movable grand piano with bench and dolly for moving. Select one of M05 or M06. Size of facility will affect type of piano required. Contact local suppliers for advice on selection.

6) **M06 - Baby Grand Piano**: Moveable baby grand piano with bench and dolly for moving. Select one of M05 or M06. Size of facility will affect type of piano required. Contact local suppliers for advice on selection.

7) **M07 - Upright Piano**: Moveable upright piano with bench and dolly for moving. Contact local suppliers for advice on selection.

8) **M08 - Refrigerator**: Contact local suppliers for advice on selection. Each unit shall have a minimum 14 cubic feet of storage volume and include compartments for freezing and cooling. Not every standard refrigerator is wide enough to hold a typical bakery sheet cake, but these are often used for celebratory events. Clarify this when specifying the refrigerator. Swing of door shall be appropriate to traffic flow in kitchen. Select a high grade residential refrigerator. Refrigerator shall be Energy Star rated, Tier I. An automatic icemaker is not required since facility will have an icemaker. Each facility shall determine what size, features, storage compartments and configurations are required to meet the requirements of the congregations since requirements may vary.

9) **M09 - Range**: Contact local suppliers for advice on selection. Recommend a single oven,

automatic control, oven viewing window, clock, oven interior light, and four burners. Coordinate cooking surface type with User, ceramic or coil surface type. A residential style range will be sufficient for most facilities, but some Garrisons may prefer a style range between residential and commercial. If a larger style range is chosen, the designer must revise the design to accommodate the different size.

10) M10 - Dishwasher: Contact local suppliers for advice on selection. Determine which capacity, control features, and dishware arrangements are required to meet the requirements of the congregations since requirements may vary. Dishwasher shall be Energy Star rated. Coordinate size of dishwasher with kitchen layout, features and casework to assure it is compatible with the kitchen configuration. Note that this item is Contractor Furnished/Contractor Installed (CF/CI).

11) M11 - Ice Machine: Contact local suppliers for advice on selection. A simple design of sturdy components and easily understood operation controls is recommended. Unit shall be Energy Star rated and use modern refrigerants. The speed of ice production and the amount of ice storage capacity can vary widely. Determine facility requirements. Discuss options with local supplier and type of ice required (cubes, half cubes, crushed, etc.) if there is a preference. Consider the unit's noise production and heat load.

12) M12 - Under Counter Refrigerator: Provide an under counter type refrigerator will be placed in the sacristy for communion items. Refrigerator shall be Energy Star rated, Tier I.

13) M13-Microwave: This microwave cooking unit may be a separate unit or may be the kind of unit that is combined with a range hood in a coordinated assembly. An under wall cabinet, over-the-range combination microwave oven and exhaust hood unit shall be coordinated with casework and other appliances. Unit shall have a minimum of 1.9 cubic feet of interior capacity and a mix of control features. Microwave shall be units designed to heat or reheat food items. Units shall include control switches for selection/adjustment of functions, timing, and power. A variety of additional options are available, as are a range of quality and performance characteristics. Contact local suppliers for advice on selection.

14) M14 - Warming Drawers: In-the-base-cabinet under counter units coordinated with casework and other appliances, capable of temperature adjustment to hold food in an optimally warm condition prior to serving. Warming drawer placement has been designed so that two can fit one above the other but below a standard countertop. Note that this item is Contractor Furnished/Contractor Installed (CF/CI).

15) M15 - Keyboard/Synthesizer: Movable keyboard/synthesizer with stand and bench. Contact local suppliers for advice on selection.

16) M16 - Outdoor Furniture (Optional): Table and chairs shall be designed for outdoor commercial use.

17) M17 - Portable Projector: Contact local suppliers for advice on selection. Portable projectors shall be units designed to receive input from laptops or cable feeds and to project the visual portions on a wall or screen. Units shall include a hand-held controlling "remote", adjustment for vertical aim, brightness, and focus. A variety of additional options are available, as are a range of quality and performance characteristics.

18) M18 - Television: Contact local suppliers for advice on selection. Flat screen televisions shall be units designed to receive input from media players, antennae or cable feeds and to show such programming as selected. Units shall include a hand-held controlling "remote", channel selection, volume control, adjustment for brightness, and focus. A variety of additional options are available, as are a range of quality and performance characteristics.

19) M19 - Media Player: Contact local suppliers for advice on selection. Media Player shall be

units designed to receive input from media transfer devices and to transmit it to networks, televisions or other displaying devices. Units shall include a hand-held controlling “remote”, adjustment for volume and programming/feature selection. A variety of additional options are available, as are a range of quality and performance characteristics.

20) **M20: Not Used**

21) **M21: Not Used**

22) **M22: Not Used**

23) **M23: Not Used**

24) **M24: Not Used**

25) **M25: Not Used**

26) **M26: Not Used**

27) **M27 - Portable Projection Screen:** Contact local suppliers for advice on selection. Portable Projection Screen shall be a premanufactured unit for that purpose with screen and integral stand in a single unit designed to “close up” and be easily stored or carried about. Minimum recommended screen size is 8-feet by 8-feet but other sizes may also be selected.

B. Ecclesiastical Equipment:

The pews shall be fixed and have upholstered cushion or non-upholstered seat, back and kneeler, contoured seat and back, and waterfall front. If upholstered, provide a “fabric” covering that is waterproof and exceptionally damage resistant. Fabrics or covering-systems suitable for out-door severe-weather-exposure use would be appropriate. Back side of pew backs shall be wood. The following standard options shall be included: storage for hymnals, communion cup holder, and pencil and envelope/card holder. Stacking pew chairs with kneeler, chancel chairs and stacking chairs for choir shall have upholstered cushion seat and back. Stacking pew chair with kneeler shall have the following standard options: ganging, and under seat bookrack. Pew and chair kneelers shall rotate for out of the way for storage. The altars, altar rail unit, communion table, credence table and offertory table shall all be constructed of solid wood and have the same style and detailing. Lectern, pulpit and kneeler/pre-dieu shall also be constructed of solid wood and have the same style and detail and coordinate closely with the altars and tables; provide them with hidden-from-view casters with brakes for ease of relocation. All kneelers shall have upholstered cushion. Chancel chairs shall also be constructed of solid wood and have the same style and detail and coordinate closely with the altars and tables. The baptismal font shall have a metal or ceramic receptor with an approximate diameter of 1'-6". The portable altar shall separate into smaller parts and or include attached handles or wheels for ease of relocation. All furniture and decorative motifs shall be non-faith group specific and coordinate with and complement the building finishes and design. Ecclesiastical equipment shall be high quality wood construction and of similar style. Furniture shall not have sharp edges. Clips, screws and other furniture construction elements shall be concealed where possible. Furniture shall be designed for ease of mobility and shall be constructed according to guidelines of the Architectural Woodwork Institute, premium grade. All veneers and solid wood pieces shall be Grade 1, premium quality, plain, quarter or rift sawn. Upholstery in Worship Areas shall meet Wyzenbeek Abrasion Test 175,000 minimum double rubs.

1) **E01 - Altar:** 5'-0" w x 2'-6" d x 3'-3" h

2) **E02: Not Used**

3) **E03 - Communion Table (Optional):** 5'-0" w x 2'-6" d x 2'-6" h

- 4) **E04 - Credence Table (Optional):** 3'-0"w x 2'-0"d x 2'-6"h
- 5) **E05 - Offertory Table:** 2'-0"w x 1'-4"d x 3'-3"h
- 6) **E06 - Lectern:** 2'-0"w x 1'-8"d x 3'-6" high at front of reading surface and 4'-0" high at back.
- 7) **E07 - Pulpit:** 2'-8"w x 2'-2"d x 3'-6" high at front of reading surface and 4'-0" high at back. Unit has internal bookshelf.
- 8) **E08 - Pews:** Provide pews as shown on the plan.
- 9) **E09 - Stacking Pew Chairs with Kneelers:** 1'-8"w x 1'-11"d x 2'-8"h
- 10) **E10 - Chancel Chair:** 2'-0"w x 2'-0"d x 3'-8"h
- 11) **E11 - Stacking Chair for Choir:** 1'-7"w x 1'-7"d x 2'-7"h
- 12) **E12 - Baptismal Font:** 2'-0"w x 2'-0"d x 3'-0"h
- 13) **E13: Not Used**
- 14) **E14 - Altar Rail Unit:** Portable altar rail unit, 4'-0"w x 1'-9"d x 2'-8"h. Unit shall have a 4'-0"w x 9"d x 2" thick upholstered cushion.
- 15) **E15: Not Used**

3.20 FACILITY SPECIFIC REFERENCES - NOT USED

This page was intentionally left blank for duplex printing.

APPENDIX A

ARMY STANDARD DESIGN AREA COMPUTATIONS

This page was intentionally left blank for duplex printing.

LARGE CHAPEL

SPACE TYPES AND NET AREAS

ROOM OR ROOM GROUP NAME	SQ. FEET	NOTES
Worship Center	17410	
Multipurpose Rooms	3500	
Baptistery Suite	410	
Resource Room	225	
Sacristy Robing Suite	440	
Audio/Visual Production Room	380	
Classroom	485	
Kitchen	226	
Pantry	74	
Recycling Center	129	
Chaplain's Office	115	
Chaplain's Office	125	
Assistant Group Office	430	
Restrooms	2065	
Janitor's Closets	120	
Storage Rooms	901	
Equipment Rooms	2350	
Circulation, Lobbies, and Vestibules	3845	
Walls, Partitions and Shafts	1483	
Gross Building Area	35,518	
Half the Canopy Area	785	
Exterior Storage Shed/Building	150	
Total Calculated Area	36,453	
Rounded Total Facility Area/Scope	37,000	

This page was intentionally left blank for duplex printing.

APPENDIX B

ARMY STANDARD DESIGN SYSTEMS DESCRIPTIONS

INDEX

DESCRIPTION 1	AUDIO/VISUAL (AV) & BROADCASTING EQUIPMENT SYSTEM
DESCRIPTION 2	CLOSED CIRCUIT TELEVISION (CCTV) EQUIPMENT SYSTEM
DESCRIPTION 3	MEETING ROOM SCHEDULING (MRS) EQUIPMENT SYSTEM

This page was intentionally left blank for duplex printing.

AUDIO/VISUAL MEDIA (A/V) & BROADCASTING SYSTEM

This system is to enhance the functional ministry and communication capabilities and to ensure a more uniform and professional worship experience for every person in the facility. Properly designed electronic A/V systems can increase the success and ease of meeting these goals; indeed, they have become essential for most contemporary worship activities.

The Army Standard Design requirements for this system are that the video portion of the A/V system shall be capable of simultaneously recording and displaying images in the Worship Center, and the Audio/Visual Production Room. The A/V system shall be capable of delivering high definition images to computer monitors, television monitors, front projection screens, and rear projection screens. (It is intended that high definition units be procured from OMA funding sources in that process.)

Images from the Worship Center shall be capable of broadcast to the Audio/Visual Production Room, Baptistery Suite Corridor, Multi-Purpose Rooms, Blessed Sacrament Room, primary Lobby, and the individual and group Offices. They shall also be capable of broadcast to an adjacent building through a separate system.

Images from the Audio/Visual Production Room shall be capable of broadcast to the Worship Center, Baptistery Suite Corridor, Nursing Mother's Room, Nursery Area, Toddler Area, Multi-Purpose Rooms, Choir Rehearsal Room, Blessed Sacrament Room, primary Lobby, and the individual and group Offices. They shall also be capable of broadcast to an adjacent building through a separate system.

The Audio portion of the A/V package shall be capable of functioning identically to the video portion of the system (recording audio and audio playback).

There shall be full coordination features between several control points for activities in the Worship Center. These include the speaker's podium located at the raised platform, the Equipment Control Console located at the raised platform, the Equipment Control Console located at the front of the balcony, and the Audio/Visual Production Room.

The speaker's podium located at the raised platform shall support only basic A/V controls (on and off switch, volume adjustment, and control of the projector program). In most cases this control location will only be used when assisting staff or volunteers are not available.

The Equipment Control Console located at the raised platform shall support relatively complete A/V controls. In most cases this control location will be used primarily to adjust the sound and image for those persons on the raised platform.

The Equipment Control Console located at the front of the balcony shall support complete A/V controls. In most cases this control location will be used primarily to adjust the sound and image for those persons in the seating areas facing the raised platform, but at times it may become the central operation point for the entire system.

The Audio/Visual Production Room shall support complete A/V controls. In most cases this control location will be used primarily to coordinate the pre-recorded sound and images transmitted to the Worship Center, etc. or the live sound and images transmitted from the Worship Center, etc. It will also be the central operation point for the production of pre-recorded sound and image programming.

The cable TV system may optionally be used to distribute audio and video to all of the other A/V capable spaces.

An integrated Public Address capability shall allow for audio messages to be broadcast from the individual and Group Offices and the Audio/Visual Production Room to all of the above spaces (somewhat selectively) and every other enclosed room except equipment rooms, storage rooms, and closets.

Note: By Army Regulation, MILCON (MCA) funding cannot generally provide the equipment for this system. MILCON (MCA) funding can currently provide infrastructure support only. The equipment must be procured and installed by the Garrison with separate funds. Where a project is to be acquired by the Request-For-Proposal (RFP) design-build process, the contract shall call for the submittal of a design proposal of sufficient detail to evaluate general quality, media and recording/broadcasting supporting features, and appropriateness. This design will then form the basis for what supporting infrastructure is to be included in the construction.

CLOSED CIRCUIT TELEVISION (CCTV) SYSTEM

This system is to enhance the safety and security for people in the facility and to protect the facility itself by providing visual monitoring of spaces. Properly designed electronic CCTV systems can increase the success and ease of meeting these goals.

The Army Standard Design requirements for this system are that it shall include CCTV monitoring of all hallways and exterior entrances. The CCTV system design shall include overlapping view areas to ensure complete coverage. The CCTV system shall include cameras and camera support equipment including a viewing monitor at an administrative office and in the space where the processing equipment is housed. It shall also provide for an auditable historic record.

Note: By Army Regulation, MILCON (MCA) funding cannot generally provide the equipment for this system. MILCON (MCA) funding can currently provide infrastructure support only. The equipment must be procured and installed by the Garrison with separate funds. Where a project is to be acquired by the Request-For-Proposal (RFP) design-build process, the contract shall call for the submittal of a design proposal of sufficient detail to evaluate general quality and appropriateness. This design will then form the basis for what supporting infrastructure is to be included in the construction.

MEETING ROOM SCHEDULING (MRS) SYSTEM

This system is to enhance the ability of facility staff and space users in the administrative processes required to assign and prepare meeting rooms, support/meet the meeting functions, and the people participating in the meetings. Properly designed electronic MRS systems can increase the success and ease of meeting these goals.

The Army Standard Design requirements for this system are that the system shall provide for computer assisted scheduling of multiple rooms at multiple times and dates and include an integrated schedule display at/for each classroom as well as a master display via that can be accessed by computer or computers. The system “core” shall be centralized and readily accessible to administrative staff. The system shall include relatively simple controlled access by non-staff. Individual displays shall be a minimum of 4-inches (diagonally) of display space, capable of legibly displaying times, purpose of reservation, and the identity of the room scheduler.

The MRS system shall allow persons to identify room capacity, features, availability, and available choices for set-up. It shall also allow them to reserve rooms and define the capacities, features, timing and selection of choices that they desire. The system will also identify how confirmation is to work, what staff persons will be involved, and allow/require them to enter personal identification information.

Note: By Army Regulation, MILCON (MCA) funding cannot generally provide the equipment for this system. MILCON (MCA) funding can currently provide infrastructure support only. The equipment must be procured and installed by the Garrison with separate funds. Where a project is to be acquired by the Request-For-Proposal (RFP) design-build process, the contract shall call for the submittal of a design proposal of sufficient detail to evaluate general quality and appropriateness. This design will then form the basis for what supporting infrastructure is to be included in the construction.

APPENDIX C

ARMY STANDARD DESIGN COST INFORMATION

This page was intentionally left blank for duplex printing.

CI14191

Estimated by CENWO-ED-C
Designed by CENWO-ED
Prepared by SLK

Preparation Date 6/26/2012
Effective Date of Pricing 6/26/2012
Estimated Construction Time 365 Days

This report is not copyrighted, but the information contained herein is For Official Use Only.

<u>Description</u>	<u>UOM</u>	<u>Quantity</u>	<u>ContractCost</u>	<u>ProjectCost</u>
Summary			16,408,860	18,990,105
Large Basic Chapel	SF	62,689.0	16,408,860	18,990,105
Substructure	SF	56,240.0	590,873	683,822
Superstructure	SF	56,240.0	1,897,019	2,195,435
Exterior Closure	LF	800.0	1,029,469	1,191,413
Roofing	SF	56,240.0	1,318,789	1,526,245
Interior Construction	SF	62,689.0	2,701,544	3,126,519
Interior Finishes	SF	62,689.0	1,055,386	1,221,407
Plumbing	SF	62,689.0	852,810	986,964
HVAC	SF	62,689.0	4,080,777	4,722,716
Fire Protection Systems	SF	62,689.0	240,240	278,032
Interior Electrical	SF	62,689.0	1,034,516	1,197,254
Other Electrical Systems	SF	62,689.0	1,266,405	1,465,620
Equipment & Furnishings	SF	56,240.0	341,031	394,678

APPENDIX D

ARMY STANDARD DESIGN DRAWINGS (UNDER SEPARATE COVER)

INDEX

G-001	COVER SHEET AND INDEX
C-111	INITIAL ENTRY CHAPEL PRIMARY GENERIC SITE PLAN EXAMPLE A
C-112	INITIAL ENTRY CHAPEL ALTERNATE GENERIC SITE PLAN EXAMPLE B
C-113	INITIAL ENTRY CHAPEL ALTERNATE GENERIC SITE PLAN EXAMPLE C
C-114	INITIAL ENTRY CHAPEL ALTERNATE GENERIC SITE PLAN EXAMPLE D
A-110	INITIAL ENTRY CHAPEL COMPOSITE FIRST FLOOR PLAN
A-120	INITIAL ENTRY CHAPEL COMPOSITE SECOND FLOOR PLAN
A-300	INITIAL ENTRY CHAPEL BUILDING SECTION & INTERIOR ELEVATION
I-110	INITIAL ENTRY CHAPEL FIRST FLOOR FURNITURE FLOOR PLAN
I-120	INITIAL ENTRY CHAPEL SECOND FLOOR FURNITURE FLOOR PLAN

BUILDING STRONG!



**US Army Corps
of Engineers** ®

Omaha District

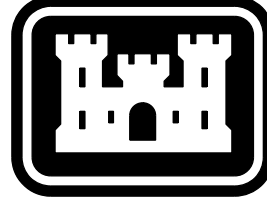

US Army Corps
of Engineers
Omaha District

INITIAL ENTRY TRAINING CONGREGATION CHAPEL (IEC)

VARIOUS LOCATIONS (CONUS)

DRAWING INDEX

GENERAL

<u>DESIGN FILE</u>	<u>SHEET NO.</u>	<u>DESCRIPTION</u>
RF-IECG-001.DGN	G-001	COVER AND INDEX
RF-IECG-002.DGN	G-002	ABBREVIATIONS
RF-IECG-003.DGN	G-003	LEGEND
RF-IECC-101.DGN	C-101	PRIMARY GENERIC SITE PLAN

ARCHITECTURAL

<u>DESIGN FILE</u>	<u>SHEET NO.</u>	<u>DESCRIPTION</u>
RF-IECA-100.DGN	A-100	COMPOSITE FLOOR PLAN
RF-IECA-120.DGN	A-120	MEZZANINE PLAN
RF-IECA-200.DGN	A-200	EXTERIOR ELEVATIONS
RF-IECA-201.DGN	A-201	EXTERIOR ELEVATIONS

INTERIORS

<u>DESIGN FILE</u>	<u>SHEET NO.</u>	<u>DESCRIPTION</u>
RF-IECI-100.DGN	I-100	FURNITURE PLAN

THIS PROJECT WAS DESIGNED BY THE OMAHA DISTRICT OF THE US ARMY CORPS OF ENGINEERS. THE INITIALS OR SIGNATURES AND REGISTRATION DESIGNATIONS OF INDIVIDUALS APPEAR ON THESE PROJECT DOCUMENTS WITHIN THE SCOPE OF THEIR EMPLOYMENT AS REQUIRED BY ER 1110-1-8152.

THE FOLLOWING SIGNATURES BELOW INDICATE OFFICIAL APPROVAL OF ALL DRAWINGS IN THIS SET DATED _____

SUBMITTED BY:	RA	SECTION
CHIEF: ARCH	SECTION	PE
SUBMITTED BY:	CIVIL	SECTION
CHIEF: CIVIL	SECTION	PE
SUBMITTED BY:	ELECT	SECTION
CHIEF: ELECT	SECTION	PE
SUBMITTED BY:	ENVR	SECTION
CHIEF: ENVR	SECTION	PE
SUBMITTED BY:	MECH	SECTION
CHIEF: MECH	SECTION	PE
SUBMITTED BY:	STRUCT/INTER	SECTION
CHIEF: STRUCT/INTER	SECTION	PE
SUBMITTED BY:	GEO	SECTION
CHIEF: GEO	SECTION	CADD
SUBMITTED BY:	PROJECT COORD.	

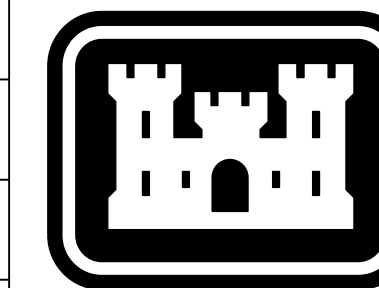

US Army Corps
of Engineers
Omaha District

FINAL DESIGN
SEPTEMBER 2011

ABBREVIATIONS

A

AB ANCHOR BOLT
 AC ALTERNATING CURRENT
 A/C AIR CONDITIONING
 ACI AMERICAN CONCRETE INSTITUTE
 ACSR ALUMINUM CABLE - STEEL REINFORCED
 ACST ACOUSTIC
 AD ACCESS DOOR
 AD AREA DRAIN
 ADMIN ADMINISTRATION/ADMINISTRATIVE
 AFCI ARC FAULT CIRCUIT INTERRUPTOR
 AFF ABOVE FINISH FLOOR
 AFFR AQUEOUS FILM FORMING FOAM
 AGGR AGGREGATE
 AHU AIR HANDLING UNIT
 A.I. AREA INLET
 AIC AMPS INTERRUPTING CAPACITY (SYM RMS)
 AISC AMERICAN INSTITUTE of STEEL CONSTRUCTION
 ALUM ALUMINUM
 A.L. ACTIVE LEAF
 ALT ALTERNATE
 AMP AMPERE
 ANSI AMERICAN NATIONAL STANDARDS INSTITUTE
 AP ACCESS PANEL
 APPD APPROVED
 APPROX APPROXIMATE
 ARCH ARCHITECTURAL OR ARCHITECT
 A.R.I. AMERICAN REFRIGERATION INSTITUTE
 ASB ASBESTOS
 ASPH ASPHALT
 ASSIST ASSISTANT
 ATC ACOUSTICAL TILE CEILING
 AUTO AUTOMATIC
 AVG AVERAGE
 AWG AMERICAN WIRE GAUGE
 AWT ACOUSTICAL WALL TREATMENT ANGLE
 BATT INSUL BATT INSULATION
 BB BULLETIN BOARD
 BC BOOKCASE
 BD BOARD
 BDRY BOUNDARY
 BEJ BRICK EXPANSION JOINT
 BITUM BITUMINOUS
 BL BUILDING LINE
 BLDG BUILDING
 BLK BLOCK
 BLKG BLOCKING
 BM BEAM
 BM BENCH MARK
 B.O. BOTTOM OF
 BOT BOTTOM
 BPRF BULLETPROOF (BULLET-RESISTANT)
 BRCC BRACING
 BRDG BRIDGING
 BRG BEARING
 BRK BRICK
 BRKT BRACKET
 BT BENT
 BTU BRITISH THERMAL UNIT
 BTUH BTU PER HOUR
 BUR BUILT-UP ROOFING
 CAP CAPACITY
 C TO C CENTER TO CENTER
 CB CATCH BASIN
 CB CIRCUIT BREAKER
 CE COVER ELEVATION
 CEM CEMENT
 CFM CUBIC FEET PER MINUTE
 CFS CUBIC FEET PER SECOND
 CFT CERAMIC FLOOR TILE
 CHIM CHIMNEY
 CI CURB INLET
 CI CAST IRON
 CIRC CIRCULAR
 CJ CONTROL JOINT
 CJ CONSTRUCTION JOINT
 CKD CHECKED
 CKT CIRCUIT
 CKT BRKR CIRCUIT BREAKER
 CL CENTER LINE
 CLG CEILING
 CLKG CAULKING
 CLO CLOSET
 CLOS CLOSED
 CLWG CLEAR WIRE GLASS
 CMP CORRUGATED METAL PIPE
 CMU CONCRETE MASONRY UNIT
 CND CONDUIT (FOR RACEWAY-ELEC. SHTS)
 CNTR COUNTER
 CO CLEANOUT
 CO CARBON MONOXIDE
 CO₂ CARBON DIOXIDE
 COL COLUMN

C (cont.)

COM COMMON
 COMB COMBINATION
 COMB COMBUSTION
 COMM COMMUNICATION
 CONC CONCRETE
 CONF CONFERENCE
 CONN CONNECTION
 CONSTR CONSTRUCTION
 CONSTR JT. CONSTRUCTION JOINT
 CONT CONTINUOUS
 COR CORNER
 CORR CORRIDOR
 COV COVERED
 CPL CEMENT PLASTER
 CPRS COMPRESSIBLE
 C.P.S. - CYCLES PER SECOND (HERTZ)
 CPT CARPET
 CRES CORROSION RESISTANT STEEL
 CRG CARRIAGE
 CRSE COURSE
 CSK COUNTER SUNK
 CST CAST STONE TILE
 CSMT CASEMENT
 CT CERAMIC TILE
 CT CURRENT TRANSFORMER
 CTL CARPET TILE
 CTR CENTER
 CU CONDENSING UNIT
 CUH CABINET UNIT HEATER
 CU YD CUBIC YARDS
 CV CEILING VENT
 CW COLD WATER
 CWT CERAMIC WALL TILE
 CYL CYLINDER
 d PENNY (as in nail - 10d)
 DA DOUBLE ACTING
 DAT DATUM
 DB DRY BULB
 DBL DOUBLE
 DC DIRECT CURRENT
 DCJ DOWELED CONTROL JOINT
 DCJT DUMMY CONTROL JOINT
 DCL DOOR CLOSER
 DCW DOMESTIC COLD WATER
 DEG DEGREE
 DEPR DEPRESSION
 DEPT DEPARTMENT
 DET DETAIL
 DF DRINKING FOUNTAIN
 DH DOUBLE HUNG
 DH DUCT HEATER
 DHW DOMESTIC HOT WATER
 DIA or Ø DIAMETER
 DIAG DIAGONAL
 DIM DIMENSION
 DIR DIRECTOR
 DISSEM DISSEMINATION
 DISC DISCONNECT
 DISTR DISTRIBUTION
 D & M DRESSED & MATCHED
 DN DOWN
 DMPF DAMPPROOFING
 DR DOOR
 DR DRAIN
 DS DOWNSPOUT
 DWG DRAWING
 DWLS DOWELS
 DX DIRECT EXPANSION
 E EAST
 EA EACH
 EA EXHAUST AIR
 EAT ENTERING AIR TEMPERATURE
 EES EMERGENCY EYEWASH & SHOWER
 EIFS EXTERIOR INSULATION & FINISH SYSTEM
 EJ EXPANSION JOINT
 EL ELEVATION - GRADE OR BUILDING
 ELEC ELECTRIC or ELECTRICAL
 ELEV ELEVATOR
 EM ENTRY MAT
 EMD ESTIMATED MAXIMUM DEMAND
 ENCL ENCLOSURE
 ENTR ENTRANCE
 EPDS EMERGENCY POWER DOWN
 EQ SWITCHEQUAL
 EQUIP EQUIPMENT
 ES EACH SIDE
 EST ESTIMATE
 EWC ELECTRIC WATER COOLER
 EWT ENTERING WATER TEMPERATURE
 EXC EXCAVATE
 EXD EXIT DEVICE
 EXH EXHAUST
 EXIST EXISTING
 EXP EXPOSED
 EXP EXPANSION
 EXPL EXPLOSION PROOF
 EXT EXTERIOR

F

F FAHRENHEIT
 FA FRESH AIR
 FC FOOTCANDLE
 FCG FACING
 FCJ FLOOR CONSTRUCTION JOINT
 FD FLOOR DRAIN
 FD FIRE DAMPER
 FDN FOUNDATION
 FE FIRE EXTINGUISHER
 FEB FIRE EXTINGUISHER BRACKET
 FEC FIRE EXTINGUISHER CABINET
 F.E.S FLARED END SECTION
 FH FIRE HYDRANT
 FHC FIRE HOSE CABINET
 FIG FIGURE
 FIN FINISH
 FIXT FIXTURE
 FLR FLOOR
 FLASH FLASHING
 FLEX FLEXIBLE
 FLG FLOORING
 FLUOR FLUORESCENT
 FP FIRE PROTECTION
 FIREPROOF FIREPROOF
 FPM FEET PER MINUTE
 FR FRAME
 FS FULL SIZE
 FT FEET
 FTG FOOTING
 FUR FURRING
 FW FIRE WATER
 FWC FABRIC WALLCOVERING
 G NATURAL GAS
 GA GAGE or GAUGE
 GAL GALLON
 GALV GALVANIZED
 GCO GRADE CLEANOUT
 GEN GENERAL
 GFCI GROUND FAULT CIRCUIT INTERRUPTOR
 GFE/CI GOVERNMENT FURNISHED EQUIPMENT CONTRACTOR INSTALLED
 GFE/GI GOVERNMENT FURNISHED EQUIPMENT GOVERNMENT INSTALLED
 GFE GOVERNMENT FURNISHED EQUIPMENT
 G.F.I. or GFI GROUND FAULT INTERRUPTOR
 GI GALVANIZED IRON
 GL GLASS
 GL GUTTER LINE
 GOVT GOVERNMENT
 GND or GRND GROUND
 GALLONS PER MINUTE
 GR GRADE
 GRS GALVANIZED RIGID STEEL CONDUIT
 GRTG GRATING
 GSU GRAZED STRUCTURAL UNIT
 GUT GUTTER
 GYP GYPSUM
 GYPSUM WALL BOARD
 GWT GLAZED WALL TILE
 HB HOSE BIBB
 HC HANDICAP
 HCD HALON CONTAINMENT DAMPER
 HD HEAD
 HDBD HARDBOARD
 HDPE HIGH DENSITY POLYETHYLENE
 HDR HEADER
 HNDRL HANDRAIL
 HDW HARDWARE
 HH HAND HOLE
 HM HOLLOW METAL
 HP HORSEPOWER
 HP HIGH PRESSURE
 H.P.T. HIGH POINT
 HR HOUR
 HS HIGH STRENGTH
 HSGYP HIGH - STRENGTH GYPSUM
 HT PLASTERHEIGHT
 HTG HEATING
 HTR HEATER
 HDWL HEADWALL
 HW HOT WATER
 HWH HOT WATER HEATER
 HYDR HYDRAULIC
 HZ HERTZ
 I or EF IRON
 IC INTERCOM
 IC INSULATED CASE
 ID INSIDE DIAMETER
 I.E. INVERT ELEVATION

I (cont.)

IESNA ILLUMINATION ENGINEERING SOCIETY of NORTH AMERICA
 IN INCHES
 INSUL INSULATION
 INT INTERIOR
 INV INVERT or INVERTER
 IP IRON PIPE
 JC JANITOR CLOSET
 J-BOX JUNCTION BOX
 JCT JUNCTION
 JST JOIST
 JT JOINT
 K THOUSAND
 KEY KEY
 KCMIL or KCM KILO CIRCULAR MIL
 KIP KILOPOUND (1000 LBS)
 KIT KITCHEN
 KL KEY LOCK
 KPL KICK PLATE
 KV KILOVOLT
 kVA KILOVOLT AMPERE
 kW KILOVOLT AMPERE REACTIVE
 kWh KILOWATT HOUR
 LAB LABORATORY
 LAT LEAVING AIR TEMPERATURE
 LAU LAUNDRY
 LAV LAVATORY
 LBR LUMBER
 LBS POUNDS
 LD LOAD
 LDG LOADING
 LG LENGTH
 LIN LINEAR
 LIS LAWN IRRIGATION SYSTEM
 LM LUMEN
 LNTL LINTEL
 LONG LONGITUDINAL
 LPS LIGHT PROOF SHADE
 LPT LOW POINT
 LR LIVING ROOM
 LR LONG RADIUS
 LT LIGHT
 LTG LIGHTING
 LT WT LIGHT WEIGHT
 LVP LOW VOLTAGE POWER
 LWT LEAVING WATER TEMPERATURE
 M THOUSAND
 MA MIXED AIR
 MACH MACHINE
 MAINT MAINTENANCE
 MAS MASONRY
 MAT MATERIAL
 MAX MAXIMUM
 M & B MATCHED & BEADED
 MC MEDICINE CABINET
 MOLDED CASE
 MCC MOTOR CONTROL CENTER
 MCJ MASONRY CONTROL JOINT
 MECH MECHANICAL
 MER MECHANICAL EQUIPMENT ROOM
 MFG MANUFACTURING
 MFR MANUFACTURER
 MG MOTOR GENERATOR
 MGT MATTE - GLAZED TILE
 MGT MANAGEMENT
 MH MANHOLE
 MIN MINIMUM
 ML METAL LATH
 ML MONOLITHIC
 MLDG MOLDING (MOULDING)
 MO MASONRY OPENING
 MOT MOTOR
 MSB MAIN SWITCH BOARD
 MSL MEAN SEA LEVEL
 MASTIC MASTIC
 MT METAL THRESHOLD
 MTD MOUNTED
 MTL METAL
 N NORTH
 NC NORMALLY CLOSED
 NCO NON COMMISSIONED OFFICER
 NEC NATIONAL ELECTRICAL CODE
 NEMA NATIONAL ELECTRICAL MANUFACTURERS ASSOCIATION
 NFPA NATIONAL FIRE PROTECTION ASSOCIATION
 NIC NOT IN CONTRACT
 NO NUMBER
 NO NORMALLY OPEN
 N.R. NOT REQUIRED

O

OA OUTSIDE AIR
 OBSURE OBSURE WIRE GLASS
 OWGL ON CENTER
 O.C. ON CENTER EACH WAY
 OCEW ON CENTER EACH WAY
 OD OUTSIDE DIAMETER
 OD OVERFLOW DRAIN
 OFF OFFICE
 OGL OBSCURE GLASS
 OH OVERHEAD
 OH OPENING
 OPNG OPPOSITE
 OPP OPERATIONS
 OPS OBSERVATION RISER
 O.R. OUTSIDE SCREW & YOKE
 OS & Y
 PA POLE
 PA PUBLIC ADDRESS
 PART PARTICLE
 PB PULL BOX
 PBS PUSH BUTTON STATION
 P.C.C. PORTLAND CEMENT CONCRETE
 P.C. POINT OF CURVE
 PC PIECE
 PERF PERFORATED
 P.E. POLYETHYLENE
 PH PHASE
 PI POINT OF INTERSECTION
 PIV POST INDICATOR VALVE
 PL PLATE
 PL or P PLASTIC LAMINATE
 PLAM L PLASTER
 PLAS PLATFORM
 PLAT PLUMBING
 PLBG PROGRAMMABLE LOGICAL CONTROLLER
 PLC
 PLG PLYWOOD
 PLYWD PLYWOOD
 PNL PANEL
 PNT PAINT
 POL POLISHED
 POL PETROLEUM, OIL, LUBRICANT
 PORC PORCELAIN
 PPM PARTS PER MILLION
 PR PAIR
 PREFAB PREFABRICATE
 PREFIN PREFINISH
 PROC PROCESSING
 PROJ PROJECT
 PRV PRESSURE REGULATING VALVE
 PRV PRESSURE REDUCING VALVE
 P.S. PRESSED STEEL
 PSF POUNDS per SQUARE FOOT
 PSI POUNDS per SQUARE INCH
 P.T. POINT OF TANGENCY
 PT POINT
 PT POTENTIAL (VOLTAGE)
 TRANSFORMER
 PORCELAIN TILE
 PAINTED
 PARTITION
 PVC POLYVINYL CHLORIDE (PLASTIC)
 PAVT PAVEMENT
 PW PASS WINDOW
 Q QUART
 QT QUARRY TILE
 QTR QUARTER
 1/4 RD QUARTER ROUND
 R RISER
 R RADIUS
 R RANGE
 RA RELIEF AIR
 RA RETURN AIR
 RAG RETURN AIR GRILLE
 RAR RETURN AIR REGISTER
 RB RESILIENT BASE
 RBR RUBBER
 RC REMOTE CONTROL
 RCP REINFORCED CONCRETE PIPE
 RCVR RECEIVER
 RD ROOF DRAIN
 RDGE RIDGE
 RECPT RECEPTACLE
 RECR RECREATION
 RECT RECTIFIER
 REF REFERENCE
 REFR REFRIGERATOR
 REG REGISTER
 REINF REINFORCE
 REM REMOVABLE
 REPRO REPRODUCE
 REQD REQUIRED
 RESIL RESILIENT
 REV REVISION
 RFG ROOFING
 RFS RAISED FLOOR SYSTEM
 RGH ROUGH

R (cont.)

RH RELATIVE HUMIDITY
 RM ROOM
 RND RND
 RPM REVOLUTIONS PER MINUTE
 RPRT RAISED PATTERN RUBBER TILE
 S SOUTH
 S SUSPENDED
 SA SUPPLY AIR
 SB SPLASH BLOCK
 S.B. SECURITY BARS
 SCHED SCHEDULE
 SCIF SENSITIVE COMPARTMENTED INFORMATION FACILITY
 SCR SCREW
 SCT STRUCTURAL CLAY TILE
 SCUT SCUTTLER
 SD SMOKE DAMPER
 SD SUBDRAIN
 SDI STEEL DECK INSTITUTE
 SECT SECTION
 SEQ SEQUENCE
 S.F. SQUARE FOOT (FEET)
 SFU STRUCTURAL FACING UNIT
 SHLDR SHOULDER
 SHT SHEATHING
 SHTHG SIMILAR
 SIM SIMILAR
 SJ STEEL JOIST INSTITUTE
 SOV SHUT OFF VALVE
 SPCL SPECIAL
 SPEC SPECIFICATION
 SPH SOUNDPROOF
 SPK SR SPACE HEATER
 SPKR SPEAKER
 SQ or □ SQUARE
 SSMR STANDING SEAM METAL ROOFING
 SST STAINLESS STEEL
 STA STATION
 STC SOUND TRANSMISSION CLASS
 STD STANDARD
 STL STEEL
 STN STONE
 STOR STORAGE
 ST PR STATIC PRESSURE
 STR STRINGER
 STRUCT STRUCTURAL
 STWY STAIRWAY
 SUB FL SUBFLOOR
 SUSP SUSPEND
 SVF SHEET VINYL FLOORING
 SW SWITCH
 SWBD SWITCHBOARD
 SYMM SYMMETRICAL
 T TREAD
 TAN TANGENT
 TCA TILE COUNCIL of AMERICA
 TE TOP ELEVATION
 TECH TECHNICAL
 TEL TELEPHONE
 TEMP TEMPERATURE
 TER TERRAZZO
 TERM TERMINAL
 TGL TOGGLE
 THK THICKNESS
 THRES THRESHOLD
 TK BD TACK BOARD
 TO TOP OF
 T.C. TOP OF CURB
 TOILET TOILET
 TOPO TOPOGRAPHY
 TRANS TRANSVERSE
 TSTAT THERMOSTAT
 TV TELEVISION
 TYP TYPICAL
 U UNIT COOLER
 UG UNDERGROUND
 UH UNIT HEATER
 UL UNDERWRITERS LABORATORIES
 UNEX UNEXCAVATED
 UNFIN UNFINISH
 UPS UNINTERRUPTIBLE POWER SYSTEM
 UR URINAL
 UTIL UTILITY
 UV UNIT VENTILATOR

V

V VOLT
 VCP VITRIFIED CLAY PIPE
 VCT VINYL COMPOSITION TILE
 VD VAULT DOOR
 VD VOLUME DAMPER
 VENT VENTILATION
 VENT VENTILATOR
 VERT VERTICAL
 VEST VESTIBULE
 VFD VARIABLE FREQUENCY DRIVE
 VOL VOLUME
 V.P.C. VERTICAL POINT OF CURVATURE
 V.P.I. VERTICAL POINT OF INTERSECTION
 V.P.T. VERTICAL POINT OF TANGENCY
 VR VAPOR RETARDER
 VS VOLTAGE REGULATOR
 VT VENT STACK
 VT VINYL-TILE
 VT VOLTAGE TRANSFORMER
 VTR VENT THRU ROOF
 VWC VINYL-WALL COVERING
 W WEST
 W WIRE
 W/W WITH
 W/O WITHOUT
 WB WET BULB
 WC WATER CLOSET
 WD WOOD
 W.D. WASTE DRAIN
 WD. BLK WOOD BLOCKING
 WD. DR. WOOD DOOR
 WW WINDOW
 WDF WIDE FLANGE
 WGL WIRE GLASS
 WH WALL HYDRANT
 WHM WATTHOUR METER
 WHT WHITE
 WI WROUGHT IRON
 WKSH WORK SHOP
 WP WEATHER PROOF
 WP WATER PROOFING
 WRB WARDROBE
 WS WASTE STACK
 WSCT WAINSCOT
 WT WEIGHT
 WWF WELDED WIRE FABRIC
 WWM WOVEN WIRE MESH
 X TRANSFORMER
 Y YARD
 YD YARD DRAIN

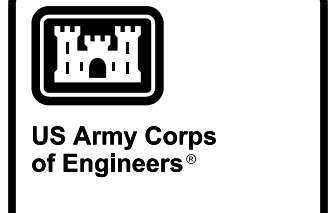

DATE	DESCRIPTION	MARK

DESIGNED BY: [blank]	CHECKED BY: [blank]
DATE: SEPTEMBER 2012	SUBMITTED BY: [blank]
U.S. ARMY ENGINEER DISTRICT	FILE NUMBER: [blank]
CORPS OF ENGINEERS	FILE NAME: sheet_001.dgn
OMAHA DISTRICT	

VARIOUS LOCATIONS
 3D BIM TRANSLATION - ARMY STANDARD DESIGN
 INITIAL ENTRY TRAINING CONGREGATION CHAPEL
 (IEC)

SHEET IDENTIFICATION
G-004

CIVIL LEGEND

Table with columns for EXISTING and NEW symbols and descriptions for CIVIL LEGEND items like BUILDINGS, ROADS, CURB & GUTTER, etc.

Table with columns for EXISTING and NEW symbols and descriptions for FENCES like CHAIN LINK SECURITY, BARBED WIRE, etc.

ARCHITECTURAL LEGEND

Table with columns for symbols and descriptions for ARCHITECTURAL LEGEND items like EARTH, CONCRETE, BRICK, WOOD, etc.

HEATING

Table with columns for symbols and descriptions for HEATING items like HPS, MPS, LPS, HPC, MPC, LPC, PC, etc.

MISCELLANEOUS PIPING

Table with columns for symbols and descriptions for MISCELLANEOUS PIPING items like COMPRESSED AIR, VACUUM, FIRE LINE, etc.

VALVES & FITTINGS

Table with columns for symbols and descriptions for VALVES & FITTINGS items like GLOBE VALVE, GATE VALVE, WAFFER CHECK VALVE, etc.

MECHANICAL LEGEND

Table with columns for symbols and descriptions for MECHANICAL LEGEND items like SUPPLY GRILLE (SG), RETURN (RG) OR EXHAUST (EG), SUPPLY REGISTER (SR), etc.

PLUMBING

Table with columns for symbols and descriptions for PLUMBING items like DOMESTIC COLD WATER, DOMESTIC HOT WATER, RECIRCULATING DOMESTIC HOT WATER, etc.

REFRIGERATION

Table with columns for symbols and descriptions for REFRIGERATION items like REFRIGERANT LIQUID, REFRIGERANT DISCHARGE (HOT GAS), etc.

TEMPERATURE CONTROLS

Table with columns for symbols and descriptions for TEMPERATURE CONTROLS items like THERMOSTAT, OUTDOOR AIR THERMOSTAT OR SENSOR, etc.

GENERAL NOTES:

- 1. THESE LEGENDS ARE COMPOSED OF STANDARD SYMBOLS AND ARE PERTINENT TO THE CONDITIONS ON THIS SET OF DRAWINGS TO THE EXTENT APPLICABLE.
2. ADDITIONAL LEGENDS AND/OR ANOTHER LEGEND SHEET MAY APPEAR IN THIS SET OF DRAWINGS TO INDICATE SPECIFIC CONDITIONS IN LIEU OF SYMBOLS SHOWN ON THIS SHEET.
3. EXISTING FACILITIES TO BE REMOVED ARE INDICATED BY USE OF THESE SYMBOLS AND HATCHED THUSLY. //

STANDARD NORTH ARROW

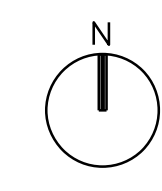

DRAWING AND DETAIL IDENTIFICATION

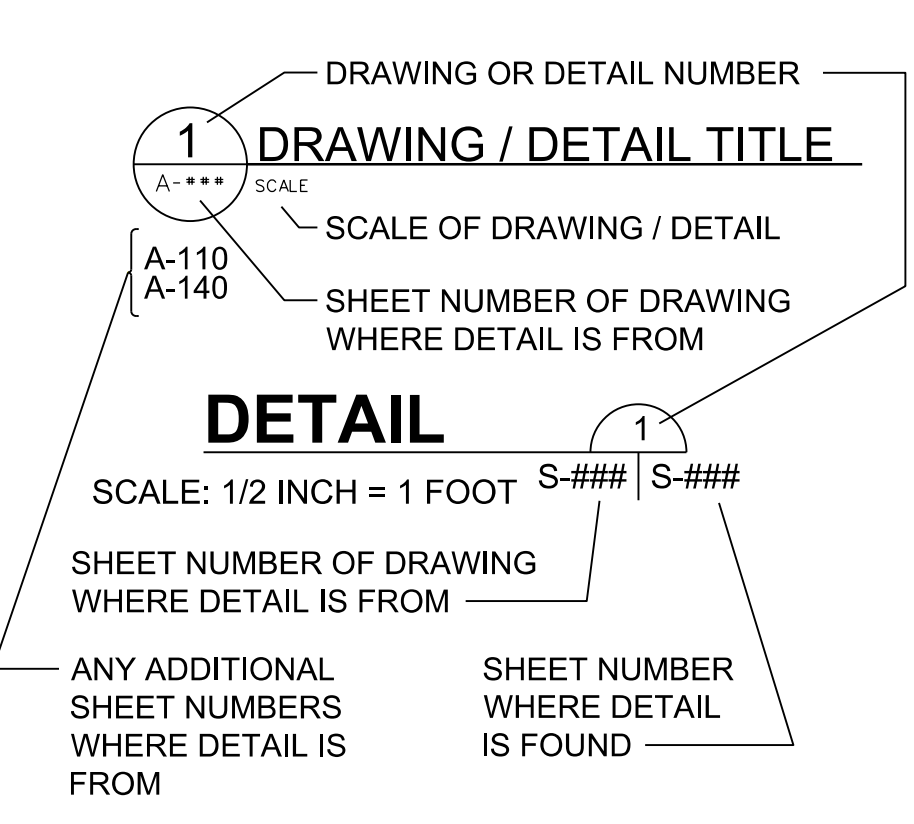

ELEVATION IDENTIFICATION

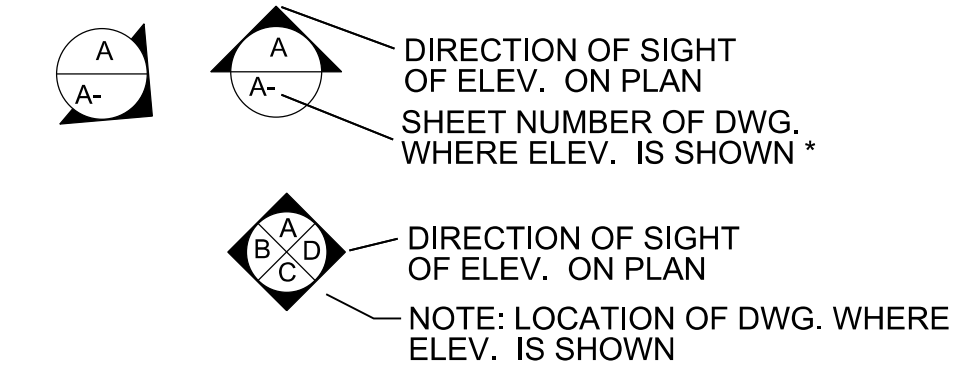

ARCHITECTURAL SYMBOLS

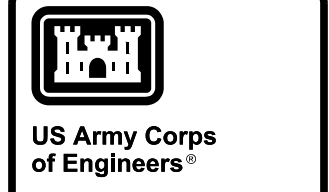
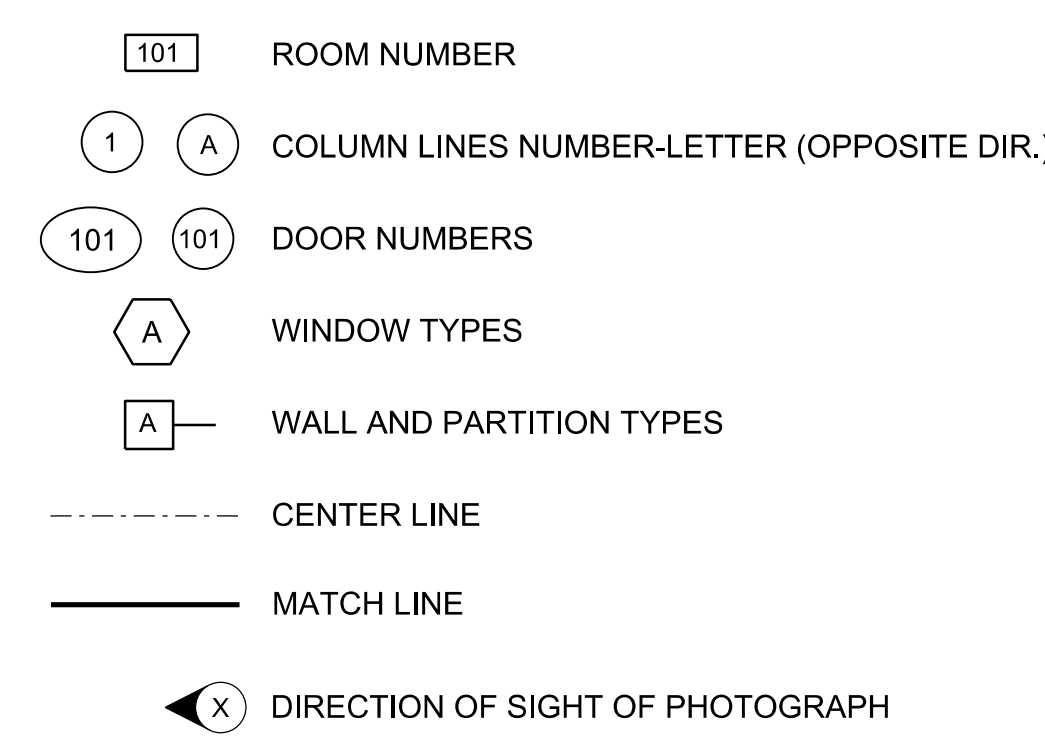

Table for drawing identification with columns for DATE, APPR., DESCRIPTION, MARK.

Table for project information with columns for DESIGNED BY, DRAWN BY, CHECKED BY, SUBMITTED BY, PLOT SCALE, PLOT DATE, FILE NUMBER, SHEET NUMBER, SIZE.

VARIOUS LOCATIONS 3D BIM TRANSLATION - ARMY STANDARD DESIGN INITIAL ENTRY TRAINING CONGREGATION CHAPEL (IEC) LEGEND

SHEET IDENTIFICATION G-005

NOTE: SEE THE ARMY STANDARD DESIGN TEXT FOR THE RELATIONSHIP BETWEEN THESE TWO FACILITIES

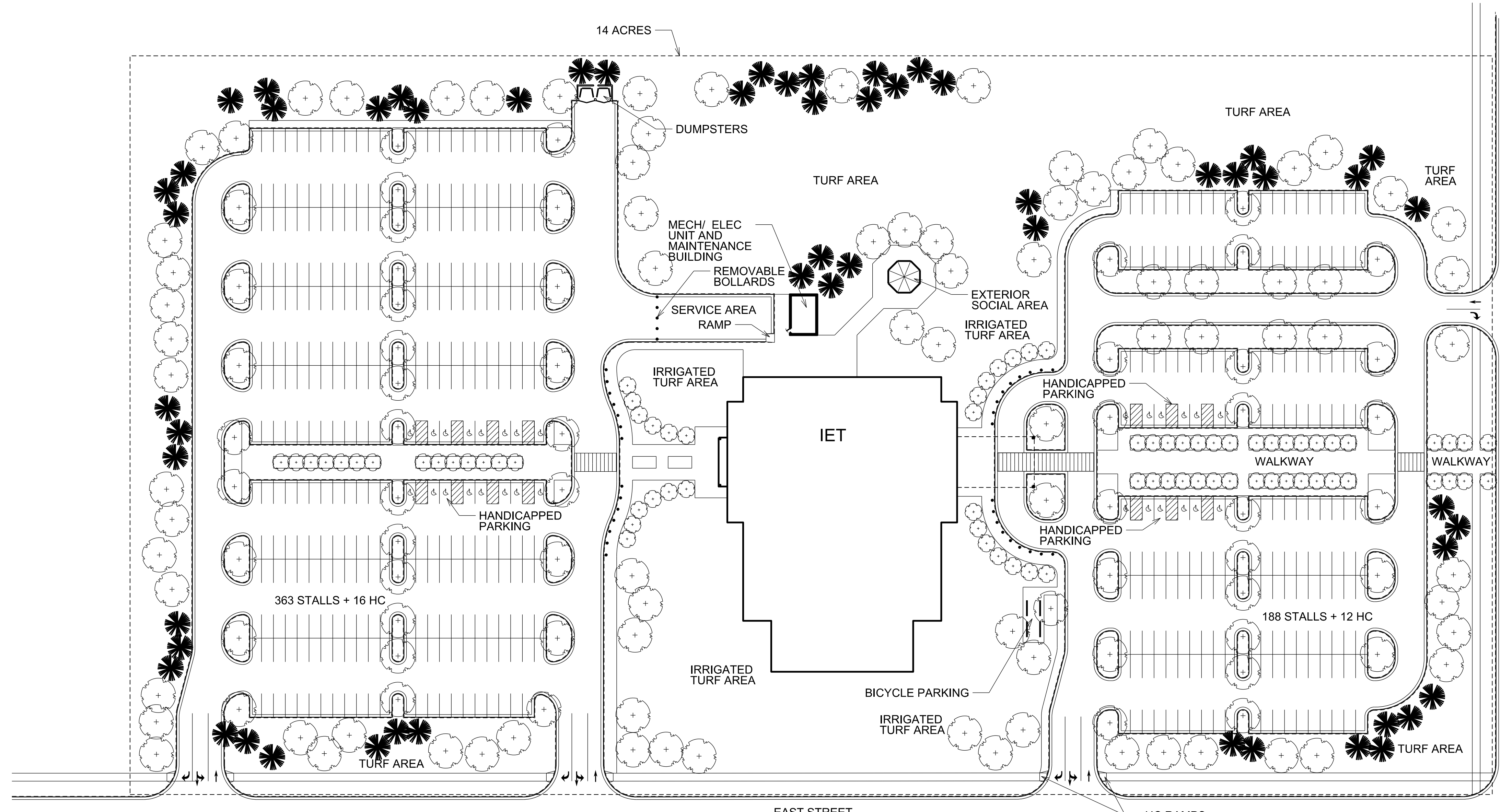

INITIAL ENTRY TRAINING FACILITY CONCEPTUAL SITE PLAN

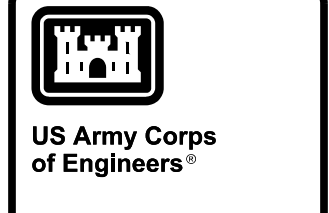

DATE	DESCRIPTION	MARK	APPR.

DESIGNED BY:	SEPTEMBER 2012
DWN BY:	SOLICITATION NO.:
SUBMITTED BY:	CONTRACT NO.:
PLOT SCALE:	PLOT DATE:
SIZE:	FILE NAME:
1:1	sheet_001.dgn

U. S. ARMY ENGINEER DISTRICT
CORPS OF ENGINEERS
OMAHA DISTRICT

VARIOUS LOCATIONS
3D BIM TRANSLATION - ARMY STANDARD DESIGN
INITIAL ENTRY TRAINING CONGREGATION CHAPEL
(IEC)
PRIMARY GENERIC SITE PLAN
EXAMPLE A

SHEET IDENTIFICATION
C-101

ROOM LEGEND

ROOM NUMBER	ROOM NAME
101	VESTIBULE
102	LOBBY
103	RESTROOM
104	RESTROOM
105	RESTROOM
106	WORSHIP CENTER
107	SACRISTY/ROBING
108	RESTROOM
109	SACRISTY/STORAGE
110	A/V CONTROL ROOM
111	STORAGE
112	AUDIO EQUIPMENT ROOM
113	CHANGING ROOM
114	CHANGING ROOM
115	CHANGING ROOM
C01	CORRIDOR
116	BAPTISTRY
117	CHANGING ROOM
118	CHANGING ROOM
C02	CORRIDOR
119	STORAGE
C03	CORRIDOR
120	STORAGE
121	LOBBY
122	EQUIP. COMM.
123	RESTROOM
124	VESTIBULE
125	RESTROOM
126	ABLUTION
127	ABLUTION
128	RESTROOM
129	JANITOR'S CLOSET
130	RECYCLE CENTER
131	STORAGE
132	MULTIPURPOSE ROOM
133	MULTIPURPOSE ROOM
134	PANTRY
135	KITCHEN
136	CLASSROOM
137	VESTIBULE
138	UTILITY LOBBY
139	RESOURCE ROOM
140	STORAGE
C04	CORRIDOR
141	MULTIPURPOSE ROOM
142	STORAGE
143	JANITORS CLOSET
144	ASSISTANT GROUP OFFICE
145	OFFICE
146	OFFICE
147	STORAGE
148	ELECTRICAL
149	MECHANICAL
150	EQUIPMENT PLATFORM

GROSS AREA:
36,478

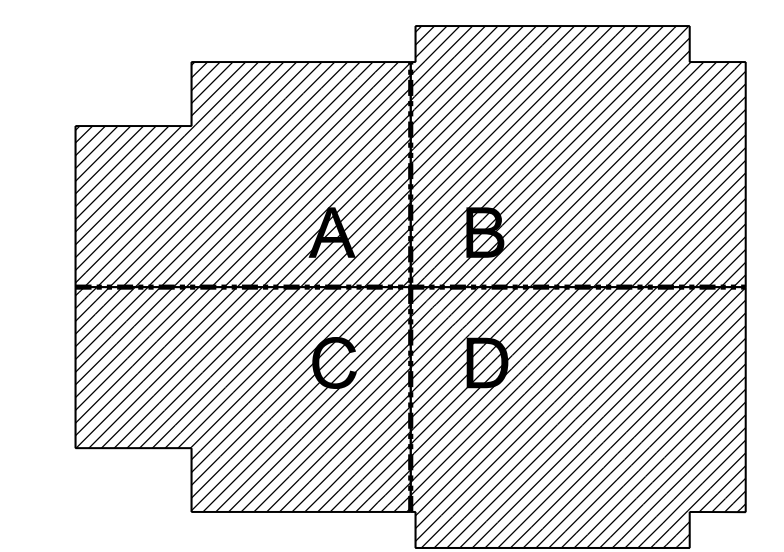
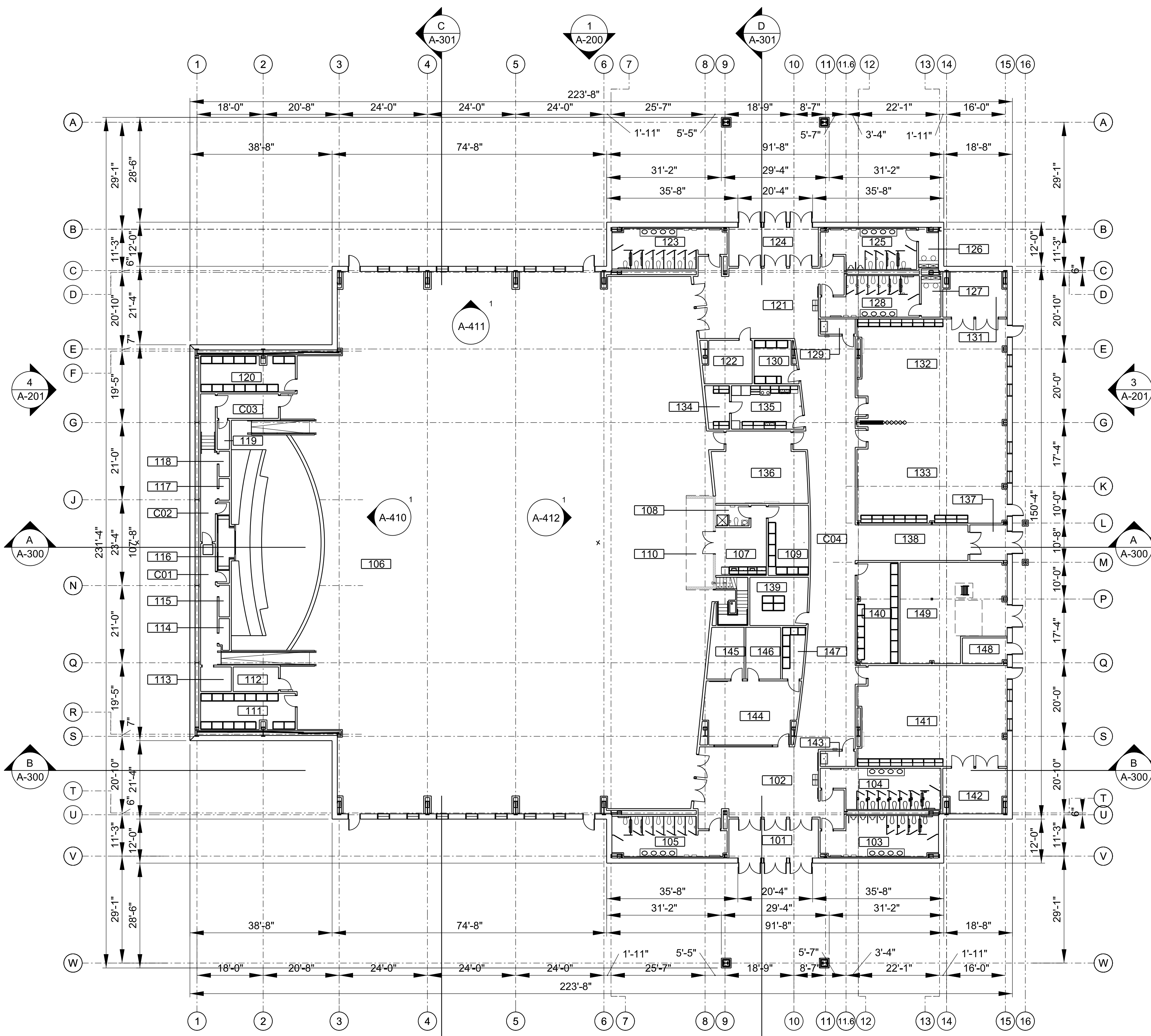

KEYPLAN

NOTES:
1. SEE SHEET A-120 FOR RM. 150, EQUIPMENT PLATFORM.

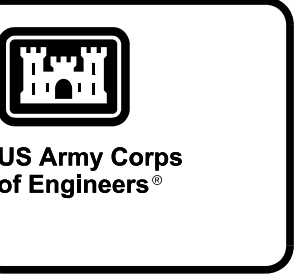

DATE	DESCRIPTION	MARK

DESIGNED BY: DATE: SEPTEMBER 2012	DRAWN BY: AMP	CHECKED BY: GFB	SCALE: 1/8" = 1'-0"	DESIGNED BY: DATE: SEPTEMBER 2012	DRAWN BY: AMP	CHECKED BY: GFB	SCALE: 1/8" = 1'-0"
U. S. ARMY ENGINEER DISTRICT CORPS OF ENGINEERS OMAHA DISTRICT	U. S. ARMY ENGINEER DISTRICT CORPS OF ENGINEERS OMAHA DISTRICT	U. S. ARMY ENGINEER DISTRICT CORPS OF ENGINEERS OMAHA DISTRICT	U. S. ARMY ENGINEER DISTRICT CORPS OF ENGINEERS OMAHA DISTRICT	U. S. ARMY ENGINEER DISTRICT CORPS OF ENGINEERS OMAHA DISTRICT	U. S. ARMY ENGINEER DISTRICT CORPS OF ENGINEERS OMAHA DISTRICT	U. S. ARMY ENGINEER DISTRICT CORPS OF ENGINEERS OMAHA DISTRICT	U. S. ARMY ENGINEER DISTRICT CORPS OF ENGINEERS OMAHA DISTRICT

VARIOUS LOCATIONS
3D BIM TRANSLATION - ARMY STANDARD DESIGN
INITIAL ENTRY TRAINING CONGREGATION CHAPEL
(IEC)
COMPOSITE FLOOR PLAN

SHEET IDENTIFICATION
A-100

1 COMPOSITE FLOOR PLAN
A-100 1/16" = 1'-0"

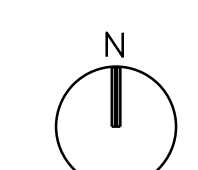
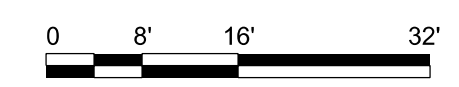

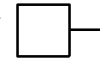

GENERAL NOTES:

- ALL WALLS ARE TYPE 5 UNLESS INDICATED OTHERWISE.
- DIMENSIONS ARE TO CENTER LINE OF COLUMNS, FACE OF STEEL STUDS FACE OF CONCRETE & FACE OF MASONRY.
- WALL TYPES INDICATED BY  MAY BE FOUND ON SHEET A-450
- ANY WALL TYPE WITH "A" FOLLOWING THE DESIGNATION NUMBER SHALL INCLUDE VAPOR RETARDER ON WARM SIDE ON CONSTRUCTION.
- DIMENSIONS NOTED WITH * ARE ESTIMATED DIMENSIONS. COORDINATE FINAL DIMENSIONS WITH PRE-ENGINEERED METAL BUILDING SUPPLIER.
- CONTRACTOR SHALL SEAL ALL PENETRATIONS TO FIRE PARTITIONS.

----- INDICATES BOUNDRY LIMIT OF BARRIER TO BE TESTED; CALCULATED SURFACE AREA IS 49,227 SF.

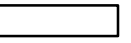
LEGEND:

-  1 X 4 LIGHT FIXTURE (SEE ELECTRICAL)
-  1 HOUR FIRE RATED PARTITION

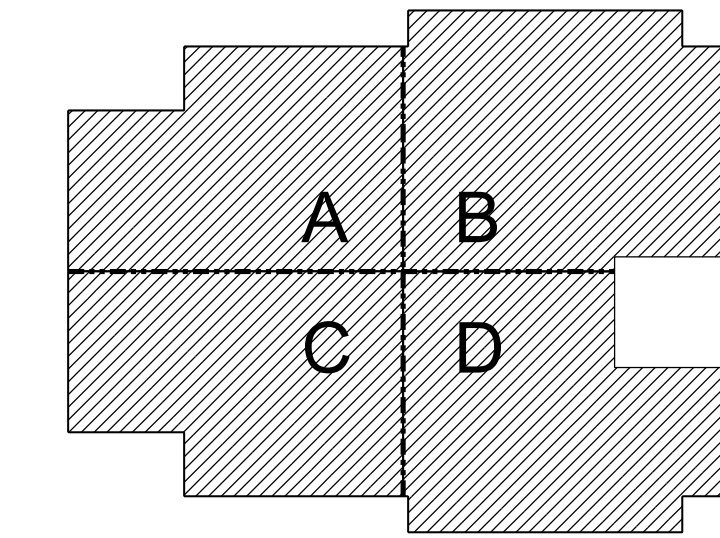

KEYPLAN

D
C
B
A

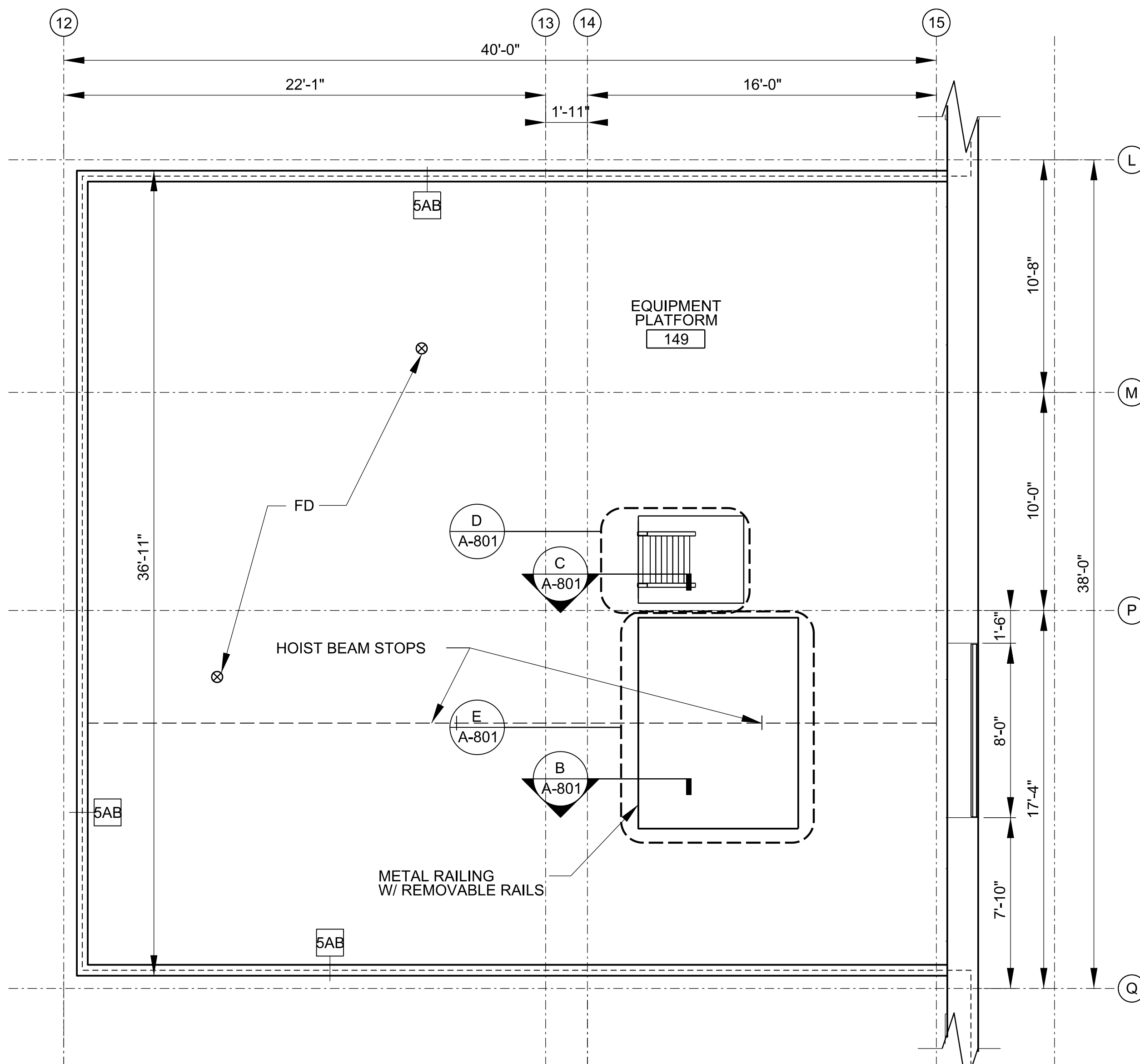

1 EQUIPMENT PLATFORM FLOOR PLAN
A-120 1/4" = 1'-0"

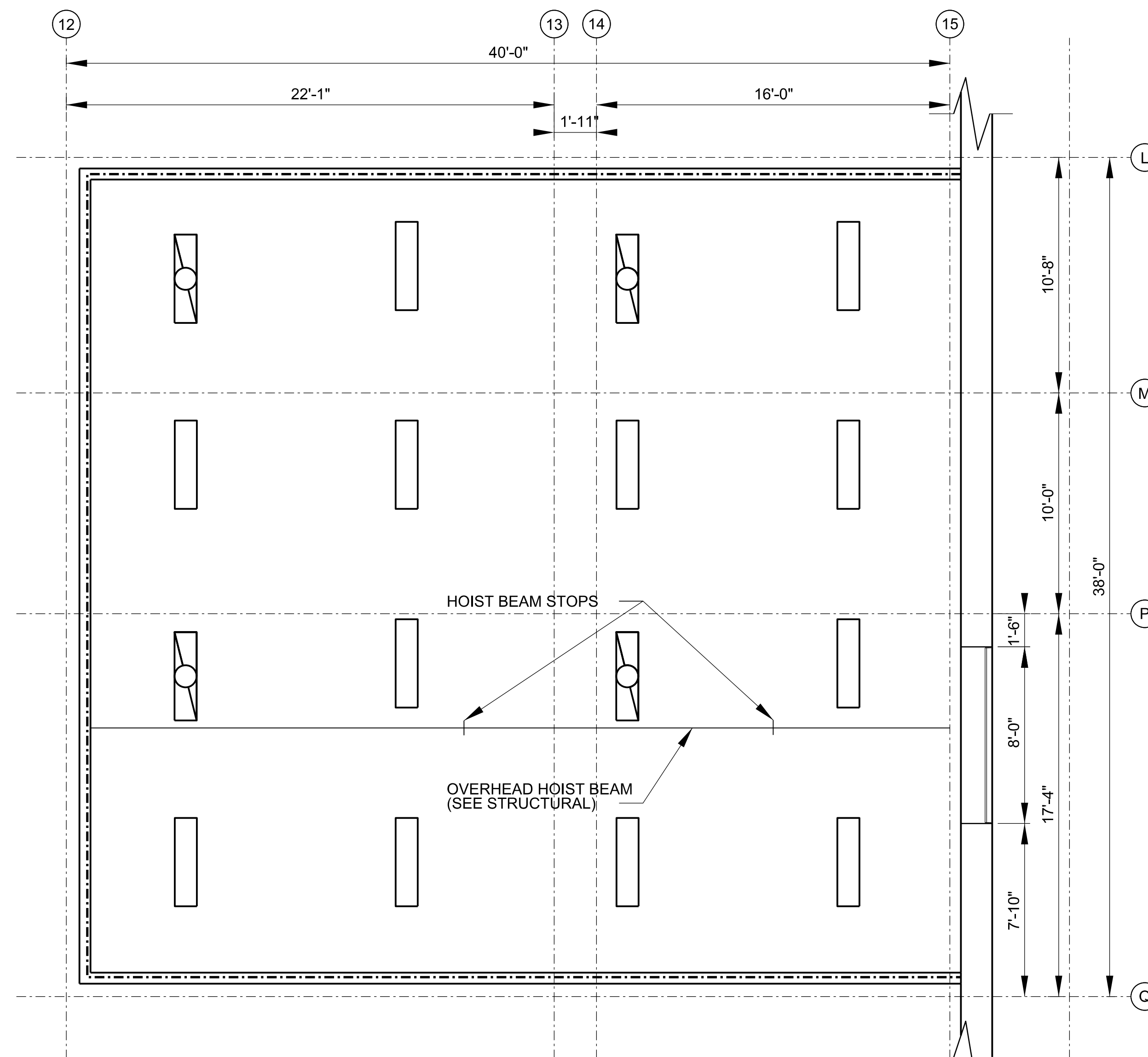

2 EQUIPMENT PLATFORM REFLECTED CEILING PLAN
A-120 1/4" = 1'-0"

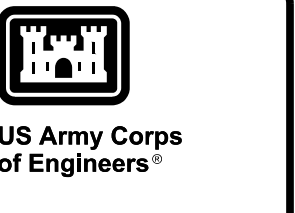
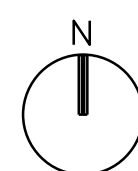
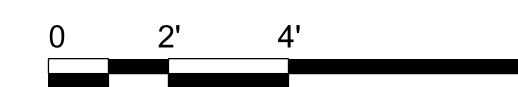

DATE	DESCRIPTION	MARK	APPR.

DESIGNED BY: AMP	DESIGNED BY: GFB	DATE: SEPTEMBER 2012	SOLICITATION NO.:
SUBMITTED BY:	SUBMITTED BY:	CONTRACT NO.:	FILE NUMBER:
PLOT SCALE: PLOT DATE:		PLOT DATE:	
SIZE: sheet_size.dgn		FILE NUMBER:	

VARIOUS LOCATIONS
3D BIM TRANSLATION - ARMY STANDARD DESIGN
INITIAL ENTRY TRAINING CONGREGATION CHAPEL
(IEC)
MEZZANINE PLAN/REFLECTED CEILING PLAN

SHEET IDENTIFICATION
A-120

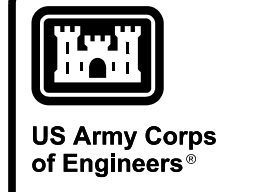

US Army Corps of Engineers®

DATE	DESCRIPTION	APPR.	MARK

DESIGNED BY: AMP	CUS BY: CFB	DATE: SEPTEMBER 2012
SUBMITTED BY:	PLOT DATE:	FILE NAME: sheet_001.dgn
U. S. ARMY ENGINEER DISTRICT CORPS OF ENGINEERS OMAHA DISTRICT	SOLICITATION NO.:	CONTRACT NO.:
	FILE NUMBER:	

VARIOUS LOCATIONS
3D BIM TRANSLATION - ARMY STANDARD DESIGN
INITIAL ENTRY TRAINING CONGREGATION CHAPEL
(IEC)

EXTERIOR ELEVATIONS

SHEET IDENTIFICATION
A-200

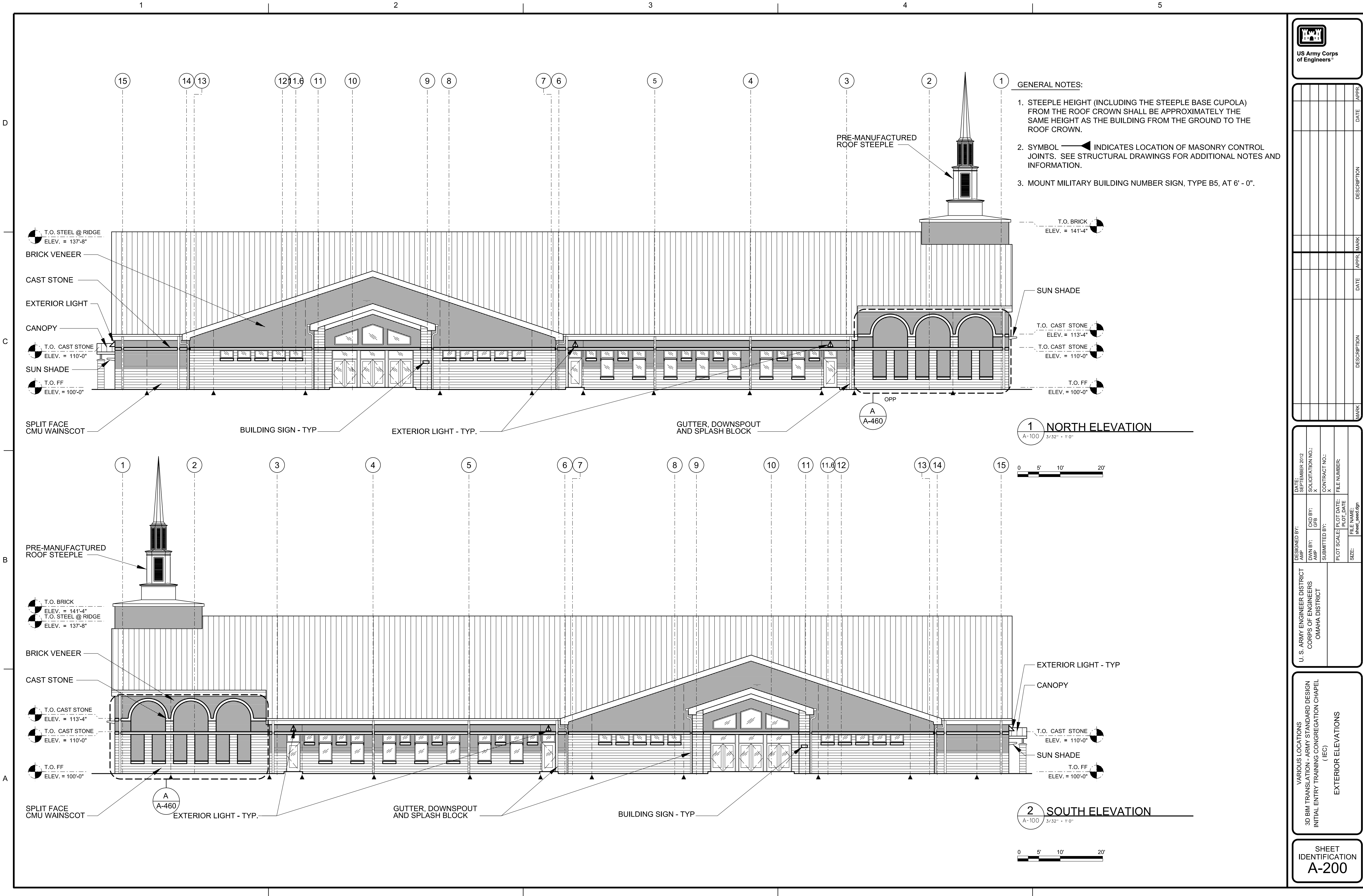

- GENERAL NOTES:**
1. STEEPLE HEIGHT (INCLUDING THE STEEPLE BASE CUPOLA) FROM THE ROOF CROWN SHALL BE APPROXIMATELY THE SAME HEIGHT AS THE BUILDING FROM THE GROUND TO THE ROOF CROWN.
 2. SYMBOL INDICATES LOCATION OF MASONRY CONTROL JOINTS. SEE STRUCTURAL DRAWINGS FOR ADDITIONAL NOTES AND INFORMATION.
 3. MOUNT MILITARY BUILDING NUMBER SIGN, TYPE B5, AT 6' - 0".

1 NORTH ELEVATION
A-100 3/32" = 1'-0"

2 SOUTH ELEVATION
A-100 3/32" = 1'-0"

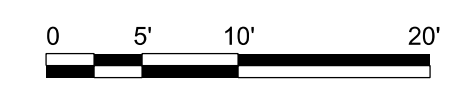
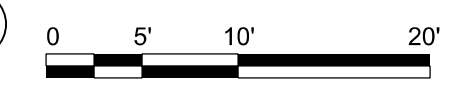

T.O. STEEL @ RIDGE
ELEV. = 137'-8"

BRICK VENEER

CAST STONE

EXTERIOR LIGHT

CANOPY

T.O. CAST STONE
ELEV. = 110'-0"

SUN SHADE

T.O. FF
ELEV. = 100'-0"

SPLIT FACE
CMU WAINSCOT

T.O. BRICK
ELEV. = 141'-4"

SUN SHADE

T.O. CAST STONE
ELEV. = 113'-4"

T.O. CAST STONE
ELEV. = 110'-0"

T.O. FF
ELEV. = 100'-0"

T.O. BRICK
ELEV. = 141'-4"

T.O. STEEL @ RIDGE
ELEV. = 137'-8"

BRICK VENEER

CAST STONE

T.O. CAST STONE
ELEV. = 113'-4"

T.O. CAST STONE
ELEV. = 110'-0"

T.O. FF
ELEV. = 100'-0"

SPLIT FACE
CMU WAINSCOT

EXTERIOR LIGHT - TYP

CANOPY

T.O. CAST STONE
ELEV. = 110'-0"

SUN SHADE

T.O. FF
ELEV. = 100'-0"



US Army Corps of Engineers

DATE	DESCRIPTION	APPR.	DATE	DESCRIPTION	APPR.

DESIGNED BY: AMP	CHECKED BY: CFB	DATE: SEPTEMBER 2012
DESIGNED BY: AMP	CHECKED BY: CFB	SOLICITATION NO.:
DESIGNED BY: AMP	CHECKED BY: CFB	CONTRACT NO.:
DESIGNED BY: AMP	CHECKED BY: CFB	FILE NUMBER:
DESIGNED BY: AMP	CHECKED BY: CFB	FILE NAME:
DESIGNED BY: AMP	CHECKED BY: CFB	FILE NAME:
DESIGNED BY: AMP	CHECKED BY: CFB	FILE NAME:

U. S. ARMY ENGINEER DISTRICT
CORPS OF ENGINEERS
OMAHA DISTRICT

VARIOUS LOCATIONS
3D BIM TRANSLATION - ARMY STANDARD DESIGN
INITIAL ENTRY TRAINING CONGREGATION CHAPEL
(IEC)
EXTERIOR ELEVATIONS

SHEET IDENTIFICATION
A-201

GENERAL NOTES:

1. STEEPLE HEIGHT (INCLUDING THE STEEPLE BASE CUPOLA) FROM THE ROOF CROWN SHALL BE APPROXIMATELY THE SAME HEIGHT AS THE BUILDING FROM THE GROUND TO THE ROOF CROWN.
2. SYMBOL INDICATES LOCATION OF MASONRY CONTROL JOINTS. SEE STRUCTURAL DRAWINGS FOR ADDITIONAL NOTES AND INFORMATION.
3. MOUNT MILITARY BUILDING NUMBER SIGN, TYPE B5, AT 6' - 0".

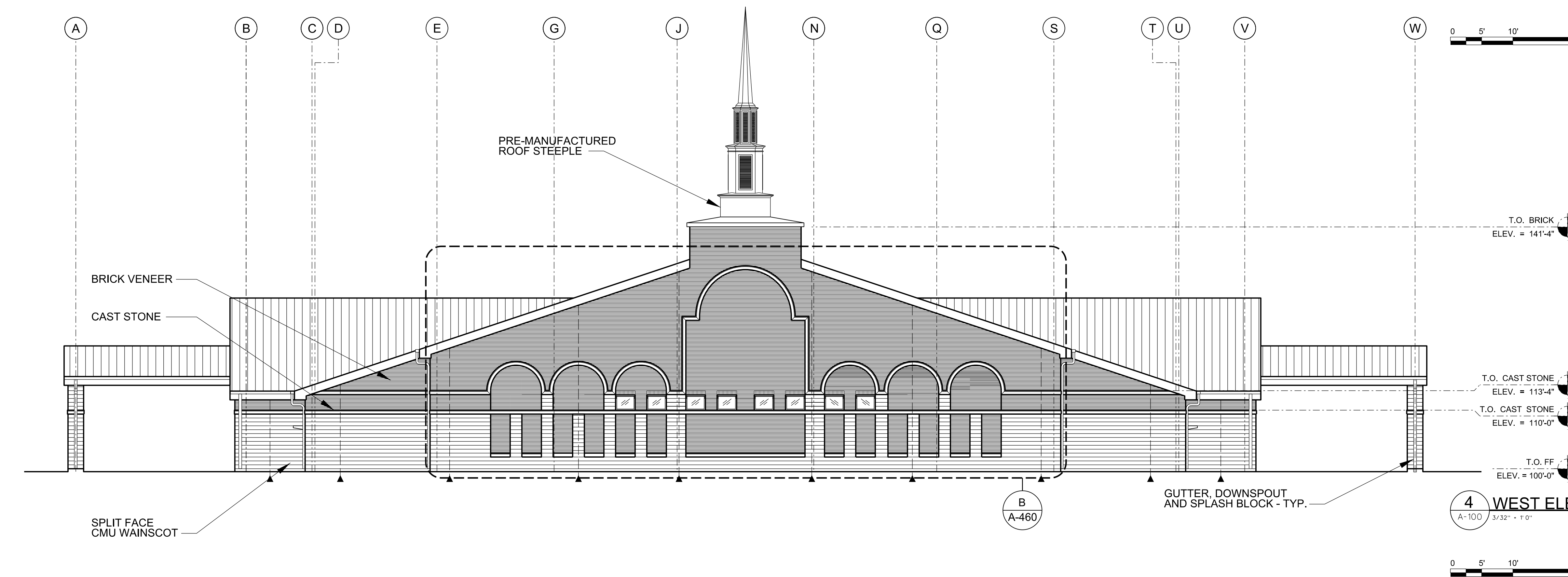
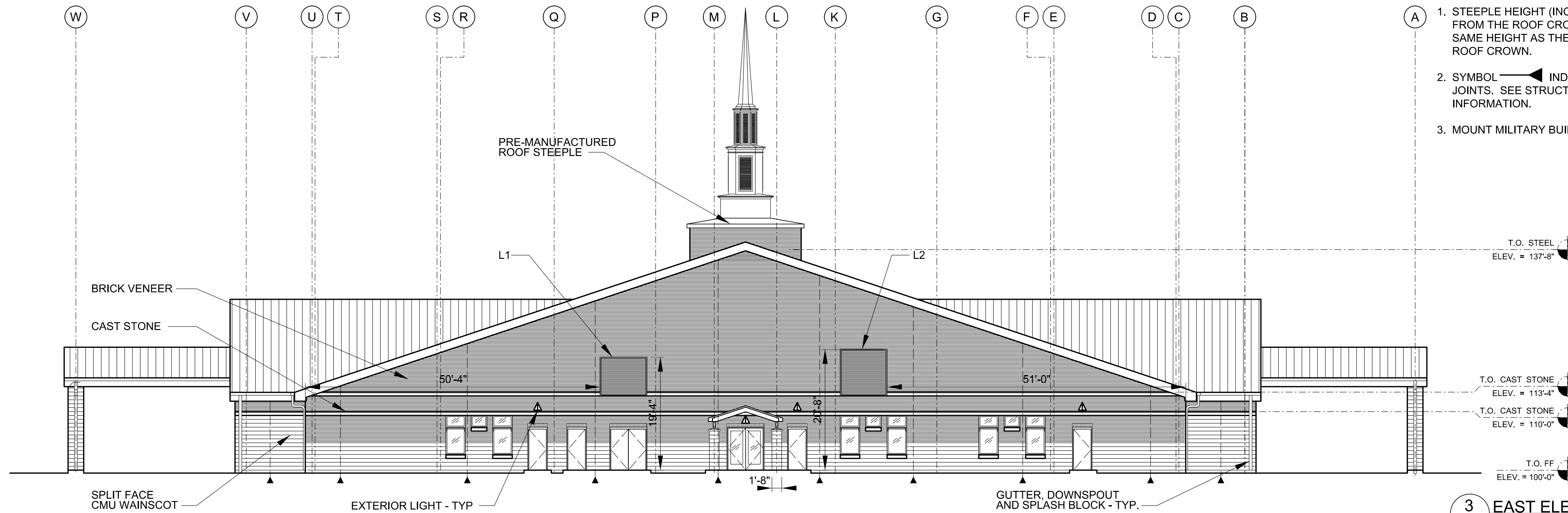

ROOM LEGEND

ROOM NUMBER	ROOM NAME
101	VESTIBULE
102	LOBBY
103	RESTROOM
104	RESTROOM
105	RESTROOM
106	WORSHIP CENTER
107	SACRISTY/ROBING
108	RESTROOM
109	SACRISTY/STORAGE
110	A/V CONTROL ROOM
111	STORAGE
112	AUDIO EQUIPMENT ROOM
113	CHANGING ROOM
114	CHANGING ROOM
115	CHANGING ROOM
C01	CORRIDOR
116	BAPTISTRY
117	CHANGING ROOM
118	CHANGING ROOM
C02	CORRIDOR
119	STORAGE
C03	CORRIDOR
120	STORAGE
121	LOBBY
122	EQUIP. COMM.
123	RESTROOM
124	VESTIBULE
125	RESTROOM
126	ABLUTION
127	ABLUTION
128	RESTROOM
129	JANITOR'S CLOSET
130	RECYCLE CENTER
131	STORAGE
132	MULTIPURPOSE ROOM
133	MULTIPURPOSE ROOM
134	PANTRY
135	KITCHEN
136	CLASSROOM
137	VESTIBULE
138	UTILITY LOBBY
139	RESOURCE ROOM
140	STORAGE
C04	CORRIDOR
141	MULTIPURPOSE ROOM
142	STORAGE
143	JANITORS CLOSET
144	ASSISTANT GROUP OFFICE
145	OFFICE
146	OFFICE
147	STORAGE
148	ELECTRICAL
149	MECHANICAL
150	EQUIPMENT PLATFORM

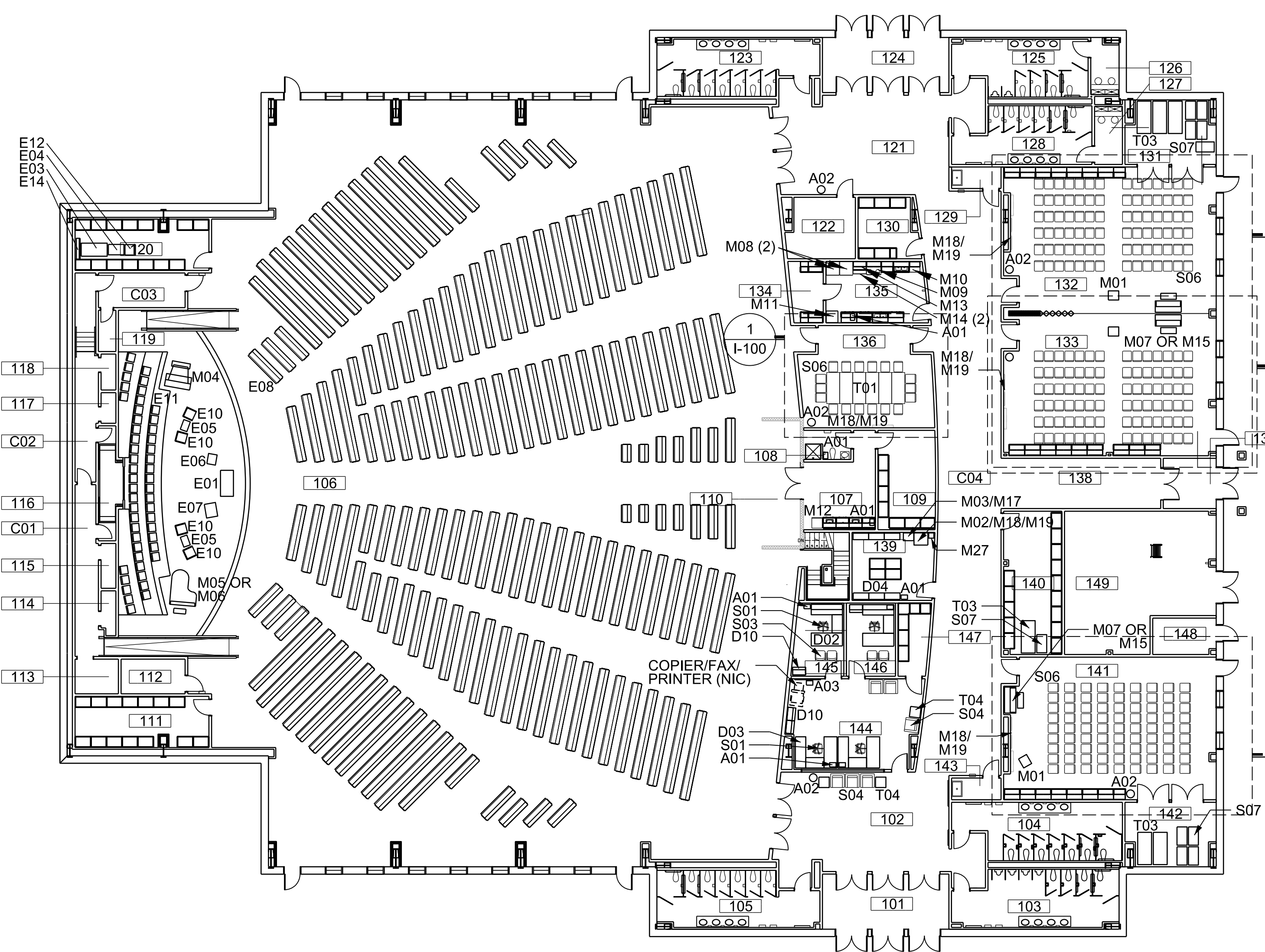

1 FURNITURE PLAN
1-100 1/8" = 1'-0"

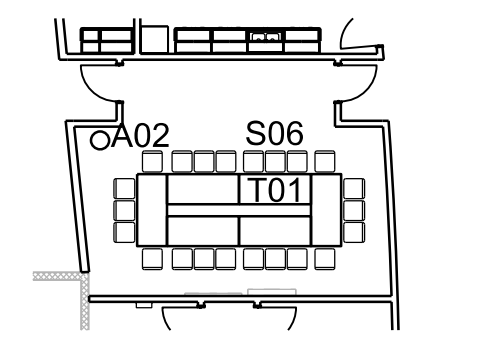

1 CLASSROOM 136
1-100 1/8" = 1'-0"

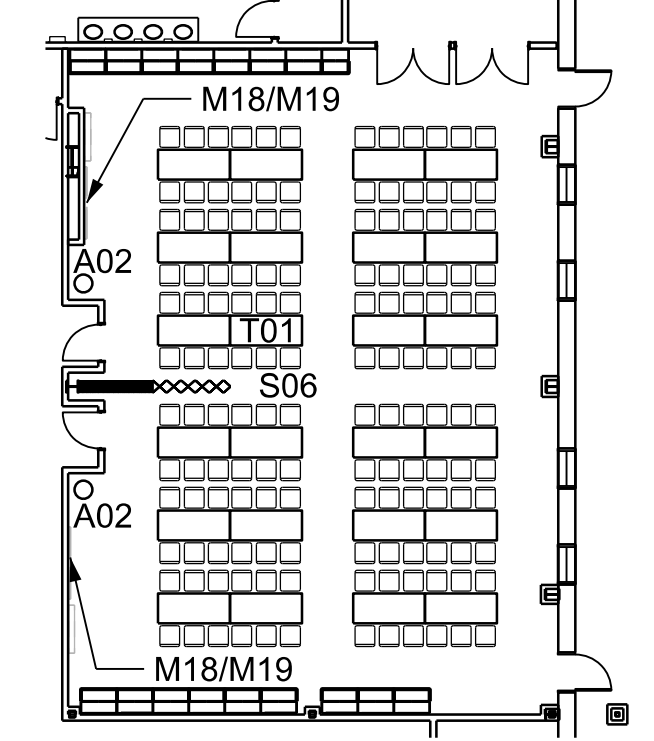

2 MULTIPURPOSE ROOM 132/133
1-100 1/8" = 1'-0"

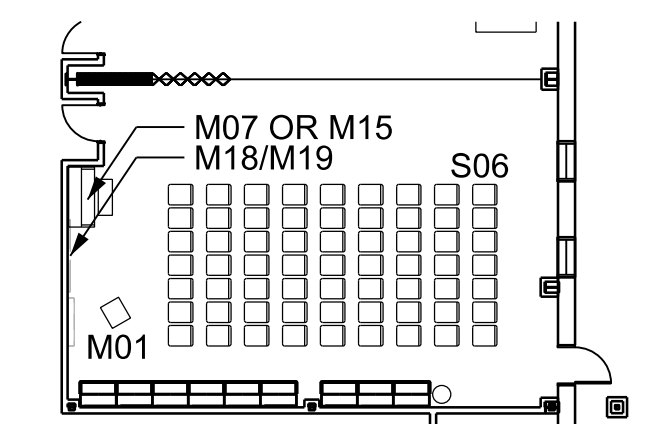

3 MULTIPURPOSE ROOM 133
1-100 1/8" = 1'-0"

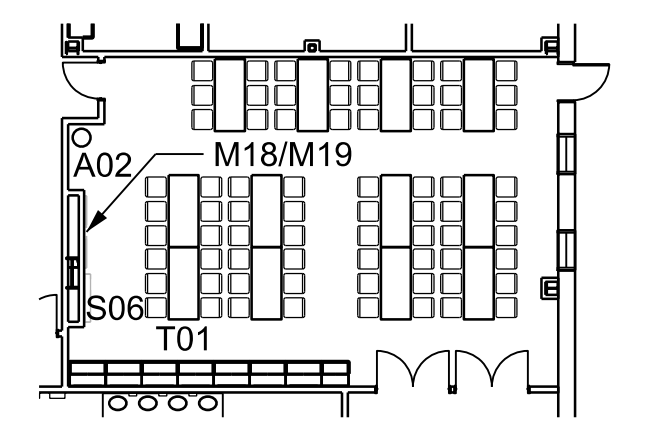

4 MULTIPURPOSE ROOM 141
1-100 1/8" = 1'-0"

FURNITURE AND EQUIPMENT LEGEND

- ECCLESIASTICAL EQUIPMENT:**
E01 ALTAR
E02 NOT USED
E03 COMMUNION TABLE (OPTIONAL)
E04 CRENDENCE TABLE (OPTIONAL)
E05 OFFERTORY TABLE
E06 LECTERN
E07 PULPIT
E08 PEW
E09 NOT USED
E10 CHANCEL CHAIR
E11 STACKING CHAIR FOR CHOIR
E12 BAPTISMAL FONT
E13 NOT USED
E14 ALTAR RAIL UNIT
E15 NOT USED
- ACCESSORIES:**
A01 SMALL TRASH RECEPTACLE
A02 LARGE TRASH RECEPTACLE
A03 PAPER RECYCLE RECEPTACLE
- DESKS AND STORAGE:**
D01 NOT USED
D02 U-SHAPED WORKSTATION, L-RETURN
D03 ADMINISTRATIVE WORKSTATION
D04 BOOKCASE
D05-D09 NOT USED
D10 LATERAL FILE W/ SHELVING
- MISCELLANEOUS:**
M01 PORTABLE PODIUM
M02 MEDIUM EQUIPMENT CART
M03 SMALL EQUIPMENT CART
M04 ORGAN
M05 GRAND PIANO
M06 BABY GRAND PIANO
M07 UPRIGHT PIANO
M08 REFRIGERATOR
M09 RANGE
M10 DISHWASHER
M11 ICE MACHINE
M12 UNDERCOUNTER REFRIGERATOR
M13 MICROWAVE
M14 WARMING DRAWER
M15 KEYBOARD/SYNTHESIZER
M16 OUTDOOR FURNITURE (OPTIONAL)
M17 PORTABLE PROJECTOR
M18 TV FLAT SCREEN
M19 MEDIA PLAYER
M20 M26 NOT USED
M27 PORTABLE PROJECTION SCREEN
M28 NOT USED
- SEATING:**
S01 DESK CHAIR
S02 NOT USED
S03 GUEST CHAIR
S04 LOUNGE CHAIR
S05 NOT USED
S06 STACKING CHAIR
S07 STACKING CHAIR DOLLY
S08-12 NOT USED
- TABLES:**
T01 MULTI-PURPOSE TABLE, 72" X 30"
T02 NOT USED
T03 TABLE DOLLY (72" X 30" TABLE)
T04 LOBBY END TABLE
T05-T06 NOT USED

NOTES:
1. REFER TO STANDARD DESIGN FUNCTIONAL/OPERATIONAL REQUIREMENTS AND A-SERIES DRAWINGS FOR LOCATIONS OF MARKERBOARDS, PRESENTATION BOARDS AND SIMILAR TYPE ITEMS.
2. REFER TO STANDARD DESIGN FUNCTIONAL/OPERATIONAL REQUIREMENTS FOR LOCATIONS AND REQUIREMENTS FOR TOILET RECEPTACLES.
3. MEZZANINE ROOM 110 A/V CONTROL ROOM IS NOT SHOWN. IT HAS TWO S01 DESK CHAIRS AND ONE A01 SMALL TRASH RECEPTACLE.

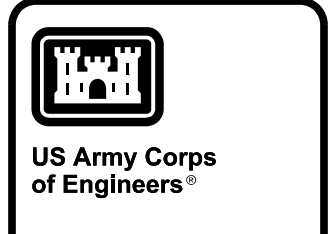

DATE	APPR	DESCRIPTION

DESIGNED BY: DATE: 2012	CUS BY: X	SOLICITATION NO.:	CONTRACT NO.:
DRAWN BY: LOH	WRE		
SUBMITTED BY: VWB		PLOT DATE:	FILE NUMBER:
		PLOT DATE:	FILE NUMBER:
		FILE NAME:	sheet_name.dgn

U. S. ARMY ENGINEER DISTRICT
CORPS OF ENGINEERS
OMAHA DISTRICT

VARIOUS LOCATIONS
3D BIM TRANSLATION - ARMY STANDARD DESIGN
INITIAL ENTRY TRAINING CONGREGATION CHAPEL
(IEC)
FURNITURE PLAN

SHEET IDENTIFICATION
I-100